



EURO STORM

20 SERIES

OPERATOR'S MANUAL

LIMITED WARRANTY:

Mandako Agri Marketing (2010) Ltd. ("MANDAKO") warrants for a period of one (1) year from the date of delivery to the purchaser that any new machinery purchased from MANDAKO (the "Product") will be free of manufacturing and materials defects (the "Covered Defects"). Before using the Product, the purchaser shall determine the suitability of the Product for its intended use. This Limited Warranty is non-transferable and valid to the purchaser of the Product only.

Except for the Covered Defects, this Limited Warranty shall not apply to any other defects or problems in the Product, including without limitation: (i) alterations, changes, replacements or repairs to the Product made by anyone other than MANDAKO or MANDAKO authorized Dealers; (ii) accessories, attachments, tools or parts sold or operated with the Product, if they have not been manufactured by MANDAKO; (iii) application or installation of accessories, attachments, tools or parts not completed in accordance with MANDAKO's operator's manual, specifications or printed instructions; (iv) defects or problems caused by misuse, abuse, neglect, improper testing, improper storage, improper handling or abnormal conditions; and (v) defects caused by wear and tear from ordinary use of the Product.

During the one (1) year warranty period, provided that written notice of the Covered Defects is given to MANDAKO within seven (7) days from the date that the defect was, or ought to have been, discovered, the liability of MANDAKO under this Limited Warranty shall be limited to the repair or replacement of any defective Product. For clarity, the purchaser shall be responsible for all expenses incurred as a result of any repairs, labour, parts, transportation or any other work, unless MANDAKO has otherwise authorized reimbursement of such expenses. In order to obtain repair or replacement, the written notice provided by the purchaser must contain full details of the Covered Defects and submitted online at www.mandako.com/warranty-claim or be sent to:

Mandako
Box 379, 12159B, Hwy 306
Plum Coulee, Manitoba, R0G 1R0

MANDAKO reserves the right to inspect the defective Product prior to repair or replacement. If MANDAKO determines that a defect in the Product is not a Covered Defect, it shall not have any obligation to repair or replace the Product.

No one is authorized to make oral warranties or representations on behalf of MANDAKO regarding the Product. The Product is subject to design changes and MANDAKO shall not be required to retro-fit or exchange items on previously sold Product, except at its own option.

THIS LIMITED WARRANTY IS DEEMED ACCEPTED BY YOU UPON YOUR PURCHASE OF THE PRODUCT. TO THE EXTENT PERMITTED BY LAW, THIS LIMITED WARRANTY IS EXCLUSIVE, AND IN LIEU OF ANY AND ALL OTHER WARRANTIES, CONDITIONS OR REPRESENTATIONS RESPECTING THE PRODUCT, EITHER EXPRESS OR IMPLIED, INCLUDING WITHOUT LIMITATION, ANY IMPLIED WARRANTIES OF MERCHANTABILITY, FITNESS FOR A PARTICULAR PURPOSE, NON-INFRINGEMENT, SUITABILITY, OR ANY OTHER WARRANTIES, REPRESENTATIONS OR CONDITIONS THAT MAY ARISE FROM USAGE OF TRADE OR COURSE OF DEALING.

MANDAKO'S OBLIGATION SHALL NOT EXTEND BEYOND THE OBLIGATIONS EXPRESSLY UNDERTAKEN ABOVE AND IN NO EVENT SHALL MANDAKO OR ITS SUPPLIERS, AGENTS, OFFICERS, DIRECTORS, CONTRACTORS AND EMPLOYEES BE LIABLE TO THE PURCHASER OR ANY THIRD PARTY FOR ANY INDIRECT, PUNITIVE, EXEMPLARY, INCIDENTAL, SPECIAL OR CONSEQUENTIAL DAMAGES OR LOSSES (INCLUDING, WITHOUT LIMITATION, DAMAGES FOR LOSS OF BUSINESS, LOSS OF PROFITS OR SALES, BUSINESS INTERRUPTION, LOSS OF BUSINESS INFORMATION, LOSS OF GOODWILL, WORK STOPPAGE, COMPUTER FAILURE OR MALFUNCTION OR ANY OTHER PECUNIARY LOSS OR COMMERCIAL DAMAGE OR LOSS) ARISING FROM ANY CLAIM WHATSOEVER, INCLUDING ANY TORT, EQUITY, NEGLIGENCE, GROSS NEGLIGENCE, WILFUL MISCONDUCT OR STRICT LIABILITY CLAIM, EVEN IF MANDAKO HAS BEEN ADVISED OF THE POSSIBILITY OF SUCH DAMAGES OR LOSSES OR THEY ARE FORESEEABLE. THE PURCHASER WAIVES ANY CLAIM AGAINST MANDAKO FOR PUNITIVE OR EXEMPLARY DAMAGES.

**WARRANTY VOID IF NOT REGISTERED
PLEASE REGISTER AT www.mandako.com/registration**

Table of Contents

<p>Section 1: INTRODUCTION..... 4</p> <p> 1.1 Serial Number Location 4</p> <p>Section 2: SAFETY 6</p> <p> 2.1 Safety Orientation 7</p> <p> 2.2 General Safety 7</p> <p> 2.3 Equipment Safety Guidelines..... 8</p> <p> 2.4 Safety Decals..... 8</p> <p> 2.4.1 General Information 8</p> <p> 2.4.2 How to Install Safety Decals 8</p> <p> 2.5 Safety Training..... 9</p> <p> 2.6 Preparation 9</p> <p> 2.7 Operating Safety10</p> <p> 2.8 Maintenance Safety.....10</p> <p> 2.9 Tire Safety11</p> <p> 2.10 Storage Safety.....11</p> <p> 2.11 Hydraulic Safety.....11</p> <p> 2.12 Transport Safety.....11</p> <p> 2.13 Safety Decals12</p> <p> 2.14 Safety Decal Locations15</p> <p>Section 3: OPERATION18</p> <p> 3.1 Machine Components19</p> <p> 3.1.1 Standard Model.....19</p> <p> 3.2 Machine Break-In.....22</p> <p> 3.2.1 After operating for 1/2 hour22</p> <p> 3.2.2 After 5 hours and 10 hours of operation:22</p> <p> 3.3 Pre-Operation Checklist22</p> <p> 3.4 Equipment matching.....23</p> <p> 3.5 Controls24</p> <p> 3.6 Attaching to a Tractor27</p> <p> 3.7 Connect Hydraulic System.....29</p> <p> 3.8 Connect the Selector Valve Control Systems.....30</p> <p> 3.9 Transport to Field Conversion.....31</p> <p> 3.10 Field Operation.....34</p> <p> 3.11 Field to Transport Conversion41</p> <p> 3.12 Transporting42</p> <p> 3.13 Storage.....43</p> <p> 3.13.1 Place in Storage43</p> <p> 3.13.2 Remove from Storage.....44</p>	<p>Section 4: SERVICE AND MAINTENANCE46</p> <p> 4.1 Fluids and Lubricants46</p> <p> 4.1.1 Grease46</p> <p> 4.1.2 Storing Lubricants.....46</p> <p> 4.1.3 Greasing46</p> <p> 4.2 Servicing Intervals.....47</p> <p> 4.2.1 Twice per Day or Every 4 Hours47</p> <p> 4.2.2 Daily or Every 8 Hours47</p> <p> 4.2.3 Every 40 Hours or Weekly47</p> <p> 4.2.4 Annually47</p> <p> 4.2.5 Every 3 Years47</p> <p> 4.3 Hydraulic Re-Phasing Circuits48</p> <p> 4.3.1 How Re-Phasing Cylinders Work48</p> <p> 4.3.2 Re-Phasing the Circuit.....48</p> <p> 4.4 Air Purging of Hitch Circuit48</p> <p> 4.4.1 How Air Purging Work48</p> <p> 4.4.2 Location Adjustment48</p> <p> 4.5 Coulter Shank Body Adjustment.....49</p> <p> 4.6 Service Record.....50</p> <p>Section 5: TROUBLESHOOTING52</p> <p>Section 6: SIGN-OFF FORM54</p> <p>Section 7: REFERENCE.....56</p> <p> 7.1 Bolt Torque56</p> <p> 7.2 Tire Pressure56</p> <p> 7.3 Hydraulic Fitting Torque.....57</p> <p> 7.4 Mechanical Specifications58</p>
---	--

SECTION 1: INTRODUCTION

Congratulations on your choice of a Mandako Euro Storm Tillage Tool to complement your farming operation. This equipment has been designed and manufactured to meet the needs of a discerning agricultural industry.

Safe, efficient and trouble free operation of your Mandako Euro Storm requires that you and anyone else who will be using or maintaining the Euro Storm read and understand the Safety, Operation, Maintenance and Troubleshooting information contained within this Operator's Manual.

This manual covers all sizes of the Mandako Storm Tillage Tool. Keep this manual handy for frequent reference and to pass on to new operators or owners. Call your Mandako dealer if you need assistance, information or additional copies of the manual.

NOTE:

The directions left, right, front, and rear, as mentioned throughout this manual, are as seen from the tractor driver's seat and facing in the direction of travel.

1.1 SERIAL NUMBER LOCATION



Fig. 1 Serial Number Location

Always give your dealer the serial number of your Storm when ordering parts or requesting service or other information.

The serial number plate is located where indicated above. Please mark the number in the space provided for easy reference.

Model Number _____

Serial Number _____

Page intentionally left blank.

SECTION 2: SAFETY

Why is SAFETY important to you?

3 Big Reasons:

- ▲ Accidents Disable and Kill
- ▲ Accidents Cost
- ▲ Accidents Can Be Avoided

This Safety Alert symbol means:
ATTENTION!
BECOME ALERT!
YOUR SAFETY IS INVOLVED!



The Safety Alert symbol identifies important safety messages on the Storm and in this manual.

When you see this symbol, be alert to the possibility of personal injury or death.

Follow the instructions in the safety message.

SIGNAL WORDS:

Note the use of the signal words DANGER, WARNING, CAUTION and ATTENTION along with the accompanying safety messages. The appropriate signal word for each message has been selected using the following guidelines:

DANGER

DANGER - Indicates an imminently hazardous situation which, if not avoided, will result in death or serious injury.

This signal word is to be limited to the most extreme situations typically for machine components which, for functional purposes, cannot be guarded.

WARNING

WARNING - Indicates a potentially hazardous situation which, if not avoided, could result in death or serious injury.

It identifies hazards that are exposed when guards are removed. It may also be used to alert against unsafe practices.

CAUTION

CAUTION - Indicates a potentially hazardous situation which, if not avoided, may result in minor or moderate injury.

It may also be used to alert against unsafe practices.

ATTENTION

ATTENTION - Indicates practices or situations which may result in the malfunction of, or damage to, the equipment.

2.1 SAFETY ORIENTATION

You are responsible for the SAFE operation and maintenance of your Mandako Storm Tillage Tool. Ensure that you and anyone else who will use, maintain or work around the Storm be familiar with the Safety, Operating and Maintenance procedures in this manual.

This manual will take you step-by-step through your working day and alerts you to all good safety practices that should be used while operating the Storm.

Remember, you are the key to safety. Good safety practices not only protect you but also the people around you. Make these practices a working part of your safety program. Be certain that everyone using this equipment follows all safety precautions, as well as the detailed operating and maintenance procedures.

Most accidents can be prevented. Do not risk injury or death by ignoring good safety practices:

- Storm owners must give operating instructions to operators or employees before allowing them to operate the machine, and review annually thereafter.
- The most important safety device on this equipment is a SAFE operator. It is the operator's responsibility to read and understand ALL safety and operating instructions in the manual and to follow them. Most accidents can be avoided.
- A person who has not read and understood all operating and safety instructions is not qualified to use the machine. An untrained operator exposes himself and bystanders to the possibility of serious injury or death.
- Do not modify the equipment in any way. Unauthorized modification may impair the function and/or safety and could affect the life of the equipment.
- Think SAFETY! Work SAFELY!

2.2 GENERAL SAFETY

- Read and understand the Operator's Manual and all safety signs before using, maintaining, adjusting or cleaning the Storm



- Have a first-aid kit available for use should the need arise and know how to use it.



- Have a fire extinguisher available for use should the need arise and know how to use it.

- Do not allow riders.

- Wear appropriate protective gear. This list includes but is not limited to:

- Hard hat
- Protective shoes with slip resistant soles
- Protective glasses, goggles, or face shield
- Heavy gloves
- Hearing protection



- Install and secure all guards before starting.

- Wear suitable ear protection for prolonged exposure to excessive noise.





- Lower machine to ground, place all controls in neutral, set park brake, stop engine, remove ignition key and wait for all moving parts to stop before servicing, adjusting, repairing or unplugging.

- Clear the area of people, especially small children, before operating the unit.

- Review safety related items annually with all personnel who will be operating or maintaining the Storm.

2.3 EQUIPMENT SAFETY GUIDELINES

- Safety of the operator and bystanders is one of the main concerns in the design and development of equipment. However, every year many accidents occur, which could have been avoided, by a few seconds of thought and a more careful approach to handling equipment.
- You, the operator, can avoid many accidents by following the precautions in this section. Insist that those working with you, or for you, follow them also.
- In order to provide a better view, certain photographs or illustrations in this manual may show an assembly with a safety shield removed. Equipment should never be used in this condition. Keep all shields in place. If shield removal becomes necessary for repairs, replace the shield prior to use. 
- Replace any safety or instructional signs that are missing or illegible. The location of these safety signs are indicated in this manual.
- Never use alcoholic beverages or drugs which can hinder alertness or coordination while using this equipment. Consult your doctor about using this machine while taking prescription medications.
- Under no circumstances should young children be allowed to work with this equipment.
- The operator should be a responsible, properly trained and physically able person. They should be familiar with machinery and trained in this equipment's operations.
- If the elderly are assisting with work, their physical limitations need to be recognized and accommodated.
- If the tow vehicle is a tractor, it should be equipped with a Roll Over Protective Structure (ROPS) and a seat belt. 
- Never exceed the limits of the Storm. If its ability to do a job, or to do so safely, is in question - DON'T TRY IT.
- Do not modify the equipment in any way. Unauthorized modification may impair the function and life of the equipment, and may result in serious injury or death.

2.4 SAFETY DECALS

2.4.1 GENERAL INFORMATION

- Keep safety decals clean and legible at all times.
- Replace decals that are missing or have become illegible.
- Replaced parts that displayed a safety decal should also display the current sign.
- Safety decals displayed in Section 2.13 each have a part number located below the sign. Use this part number when ordering replacements.
- Safety decals are available from your authorized Distributor or Dealer Parts Department.

NOTE:

Call Mandako directly if you are unfamiliar with who your local Dealer/Distributor is.



2.4.2 HOW TO INSTALL SAFETY DECALS

1. Ensure that the installation area is clean and dry.
2. Ensure temperature is above 50°F (10°C).
3. Determine exact position before you remove the paper backing. (See Section 2.13)
4. Remove the smallest portion of the split backing.
5. Align the decal over the specified area and carefully press the small portion with the exposed adhesive in place.
6. Slowly peel back the remaining paper and carefully smooth the rest of the decal in place.
7. Small air pockets can be pierced with a pin and smoothed out using the piece of the paper backing.

2.5 SAFETY TRAINING

- Safety is a primary concern in the design and manufacture of our products. Unfortunately, our efforts to provide safe equipment can be wiped out by a single careless act of an operator or bystander. 
- Accident prevention and identifying hazards are dependent upon the proper training of personnel. Their awareness, concern and common sense are crucial when involved with the operation, transport, maintenance and storage of the equipment.
- Working with unfamiliar equipment can lead to careless injuries. Read this manual to become acquainted with the machine.
- Whether the machine owner is the operator, loans or rents it out, it is their responsibility to make certain that the borrower reads and understands the operator's manuals.
- Know your controls, how to stop the tow unit, the engine, and machine quickly in an emergency.
- Train all new personnel and review instructions frequently with existing workers. Be certain only a properly trained and physically able person will use the machinery.
- A person who has not read and understood all operating and safety instructions is not qualified to use the machine. An untrained operator exposes himself and bystanders to the possibility of serious injury or death.
- If the elderly are assisting with the work, their physical limitations need to be recognized and accommodated.

2.6 PREPARATION



- Never use the Storm until you have read this Manual, and the tow unit's Operator's Manual. Take note of each Safety Message found on the safety decals on the Storm and the power unit. 
- Personal protective equipment including a hard hat, safety glasses, safety shoes and gloves are recommended during assembly or installation, operation, adjustment, maintaining or repairing, cleaning or moving the unit. 
- Do not allow long hair, loose fitting clothing or jewelry to be around equipment.
- **PROLONGED EXPOSURE TO LOUD NOISE MAY CAUSE PERMANENT HEARING LOSS!**
- Power equipment with or without equipment attached can often be noisy enough to cause permanent or partial hearing loss. We recommend that you wear hearing protection on a full-time basis if the noise in the Operator's position exceeds 80db. 
- Noise over 85db on a long-term basis can cause severe hearing loss. Noise over 90db adjacent to the Operator over a long-term basis may cause permanent, total hearing loss.

NOTE:





Hearing loss from loud noise (from tractors, chain saws, radios, and other such sources close to the ear) is cumulative over a lifetime without hope of natural recovery.

- When towing with a tractor, use only with a tractor equipped with an approved Roll-Over-Protective-Structure (ROPS). Always wear a seat belt. Serious injury or even death could result from falling off the tractor. If a roll-over occurs, the operator could be pinned under the ROPS or inside the tractor. 
- Clear working area of stones, branches or hidden obstacles that might be hooked or snagged, causing damage or injury.
- Ensure the machine is properly attached, adjusted and in good operating condition.
- Ensure that all safety shielding and safety decals are properly installed and in good condition.

2.7 OPERATING SAFETY

- Read and understand the Operator's Manual and all safety signs before using. Review safety instructions annually. 
- Lower machine to the ground, place all controls in neutral, stop engine, set park brake, remove ignition key, and wait for all moving parts to stop before servicing, adjusting, repairing or unplugging.
- Install and secure all guards and shields before starting or operating.
- Keep hands, feet, hair and clothing away from all moving and/or rotating parts. 
- Do not allow riders on the Storm or tow vehicle during operation or transporting.
- Clear the area of all bystanders, especially children, before starting.
- Stay away from all frames and components when folding or extending. Keep others away.
- Clean reflectors, SMV (Slow Moving Vehicle) emblem and lights before transporting. Ensure you are in compliance with all federal and local regulations regarding transport of equipment on public roads and highways. 
- Install cylinder stops/transport lock brackets and close ball valves in hydraulic lines before transporting or working under the frame.
- Do not exceed a safe travel speed.
- Use hazard flasher on tow vehicle when transporting.
- Before applying pressure to the hydraulic system, make sure all components are tight and that steel lines, hoses and couplings are in good condition.
- Fold wings and install transport lock brackets with its retainer over wheel lift cylinder before transporting.
- Stay away from overhead power lines when folding or extending wings. Electrocutation can occur without direct contact.
- Attach securely to towing unit using a hardened pin with a retainer and a safety chain.
- Review safety instructions annually.
- Do not drive while impaired.

2.8 MAINTENANCE SAFETY

- Good maintenance is your responsibility. Poor maintenance is an invitation for trouble.
 - Follow good shop practices.
 - Keep service area clean and dry. 
 - Ensure electrical outlets and tools are properly grounded.
 - Use adequate light for the job at hand.
- Lower machine to the ground. Place all controls in neutral, stop engine, set the park brake, remove ignition key, and wait for all moving parts to stop before servicing, adjusting, repairing or unplugging.
- Place stand or blocks under the frame before working beneath the machine or when changing tires.
- Always use personal protective equipment such as safety glasses, gloves and hearing protection, when performing any service or maintenance work. 
- Where replacement parts are necessary for periodic maintenance and servicing, genuine factory replacement parts must be used to restore your equipment to original specifications.
- A fire extinguisher and first aid kit should be kept readily accessible while performing maintenance on this equipment. 
- Relieve pressure on the hydraulic system before servicing or disconnecting from tractor.
- Before applying pressure to a hydraulic system, make sure all components are tight and that steel lines, hoses and couplings are in good condition.
- When completing a maintenance or service function, make sure all safety shields and devices are installed before placing unit in service. 

2.9 TIRE SAFETY

- Failure to follow proper procedures when mounting a tire on a wheel or rim can produce an explosion which may result in serious injury or death.
- Do not attempt to mount a tire unless you have the proper equipment and experience to do the job.
- Have a qualified tire dealer or repair service perform required tire maintenance.
- When replacing worn tires, make sure they meet the original tire specifications. Never under size.



2.10 STORAGE SAFETY

- Store the unit in an area away from human activity
- Store the unit in a dry, level area. Support the tires with planks if required.
- Lower wings and frame to the ground for storage.
- Do not allow children to play on or around the stored machine.

2.11 HYDRAULIC SAFETY

- Always place all tractor hydraulic controls in neutral before dismounting.
- Make sure that all components in the hydraulic system are kept in good condition and are clean.
- Replace any worn, cut, abraded, flattened or crimped hoses and steel lines.
- Relieve pressure from hydraulic circuit before servicing or disconnecting from tractor.
- Do not attempt any makeshift repairs to the hydraulic lines, fittings or hoses by using tape, clamps or cements. The hydraulic system operates under extremely high-pressure, such repairs will fail suddenly and create a hazardous and unsafe condition.
- Wear proper hand and eye protection when searching for a high-pressure hydraulic leak. Use a piece of wood or cardboard as a backstop instead of hands to isolate and identify a leak.
- If injured by a concentrated high-pressure stream of hydraulic fluid, seek medical attention immediately. Serious infection



or toxic reaction can develop from hydraulic fluid piercing the skin surface.

- Before applying pressure to the system, make sure all components are tight and that lines, hoses and couplings are in good condition.

2.12 TRANSPORT SAFETY

- Read and understand ALL the information in the Operator's Manual regarding procedures and SAFETY when operating the Storm in the field and/or on the road.
- Maintain wheel bolts to specified torque.
- Check with local authorities regarding Storm transport on public roads. Obey all applicable laws and regulations.
- Always travel at a safe speed. Use caution when making corners or meeting traffic.
- Clean reflectors, SMV (Slow Moving Vehicle) emblem and all the lights before transporting. Ensure you are in compliance with all federal and local regulations regarding transport of equipment on public roads and highways.
- Install additional lights on the rear of the machine to safeguard against rear end collisions. Daybreak and dusk are particularly dangerous and pilot vehicles are recommended.
- Install wheel cylinder lock brackets and close valves in hydraulic lines before transporting or working under the frame.
- Ensure that the machine is securely hitched to the towing vehicle and a retainer is used through the drawbar pin. Always attach a safety chain between the frame and the towing machine.
- Stay away from overhead power lines when raising wings. Electrocutation can occur without direct contact.
- Raise wings and install lock brackets over wheel cylinders before transporting.
- Keep to the right and yield the right-of-way to allow faster traffic to pass. Drive on the shoulder of the road, if permitted by law.
- Do not exceed 32 km/h (20 mph) on highway transport. Reduce speed on rough roads and surfaces.
- Always use hazard warning flashers on tow vehicle when transporting unless prohibited by law.
- Do not drive while impaired.



2.13 SAFETY DECALS

The various safety decals, and their locations on the equipment are shown in the illustrations to follow.



Good safety practices require familiarizing yourself with the decals. Read the warning messages, and note the area, or particular function related to that area, that the decal highlights.

If safety decals have been damaged, removed, become illegible, or replacement parts do not have the decal, new ones must be applied. Safety decals are available from your authorized dealer.

Mandako reserves the right to update safety decals without notice. Safety decals may not be to scale or exactly as shown.

 WARNING	
<p>TO PREVENT SERIOUS INJURY OR DEATH:</p> <ul style="list-style-type: none"> - Read and understand the Operator's Manual and all safety signs before using. Review safety instructions annually. - Place all controls in neutral, stop tractor engine, set park brake and wait for all moving parts to stop before servicing, adjusting, repairing or unplugging implement. - Install and secure all guards and shields before starting or operating. - Keep hands, feet, hair and clothing away from all moving and / or rotating parts. - Do not allow riders on the implement or tractor during operation or transportation. - Stay away from all extending or folding frames and components. Keep others away. - Ensure reflectors, SMV and lights are clean and visible before transporting. Be sure lights are working. 	<ul style="list-style-type: none"> - Stay away from overhead power lines when folding or extending frames and components. Electrocution can occur without direct contact. - Attach to towing unit securely using a hardened pin with retainer and a safety chain. - Do not exceed a safe travel speed. - Use hazard flashers on tractor when transporting. - Before applying pressure to the hydraulic system, make sure all components are tight and that steel lines, hoses and couplings are in good condition. - When repairing or servicing implement, refer to Operator's Manual. <div style="text-align: right;">  </div>
<small>R9913114</small>	

Part No. R9913114 (A)

 WARNING	
	<p style="text-align: center;">CRUSHING HAZARD</p> <p>TO PREVENT SERIOUS INJURY:</p> <ul style="list-style-type: none"> - Stay clear of moving parts.
<small>R9913113</small>	

Part No. R9913113 (B)

 WARNING	
	<p style="text-align: center;">HIGH PRESSURE FLUID HAZARD</p> <p>TO PREVENT SERIOUS INJURY OR DEATH FROM HIGH PRESSURE FLUID:</p> <ul style="list-style-type: none"> - Relieve pressure on system before repairing or adjusting. - Wear proper hand and eye protection when searching for leaks. Use wood or cardboard instead of hands. - Keep all components in good repair.
	<small>R9913110</small>

Part No. R9913110 (C)

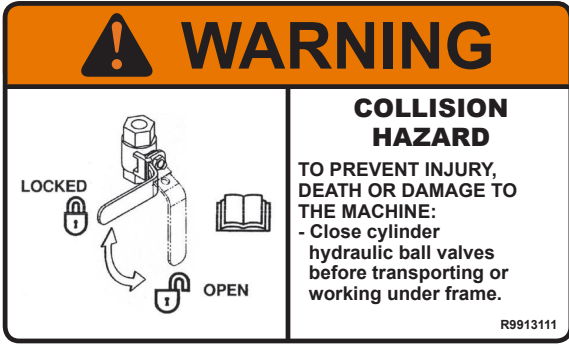

Part No. R9913111 (D)

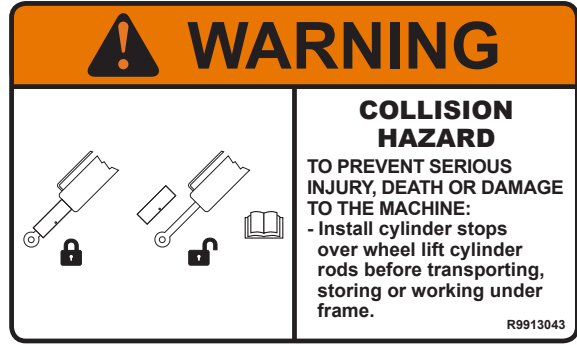

Part No. R9913043 (E)

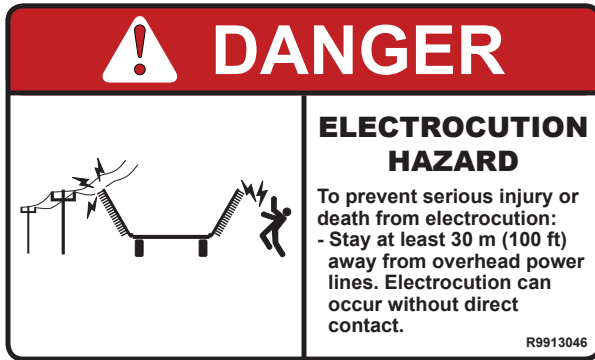

Part No. R9913046 (F)



Part No. R9913045 (G)



Part No. R9913124 (H)



Part No. R9913103 (I)

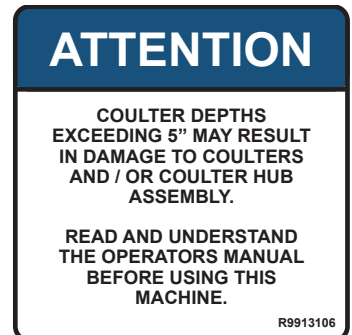

Part No. R9913106 (J)



Part No. R9913073 (K)



Part No. R9913004 (L)



Part No. R9913002 (M)



Part No. R9913003 (N)

2.14 SAFETY DECAL LOCATIONS

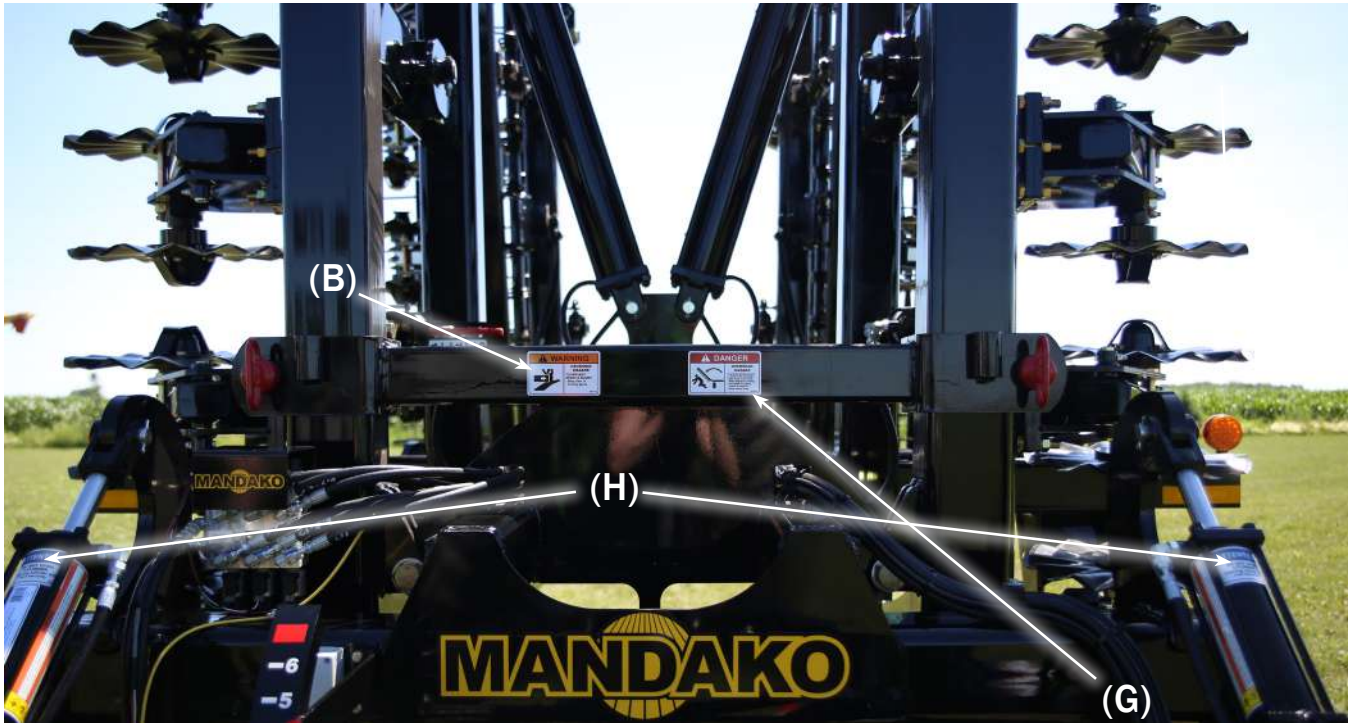

NOTE:

Decal (H) is located on each hydraulic cylinder.

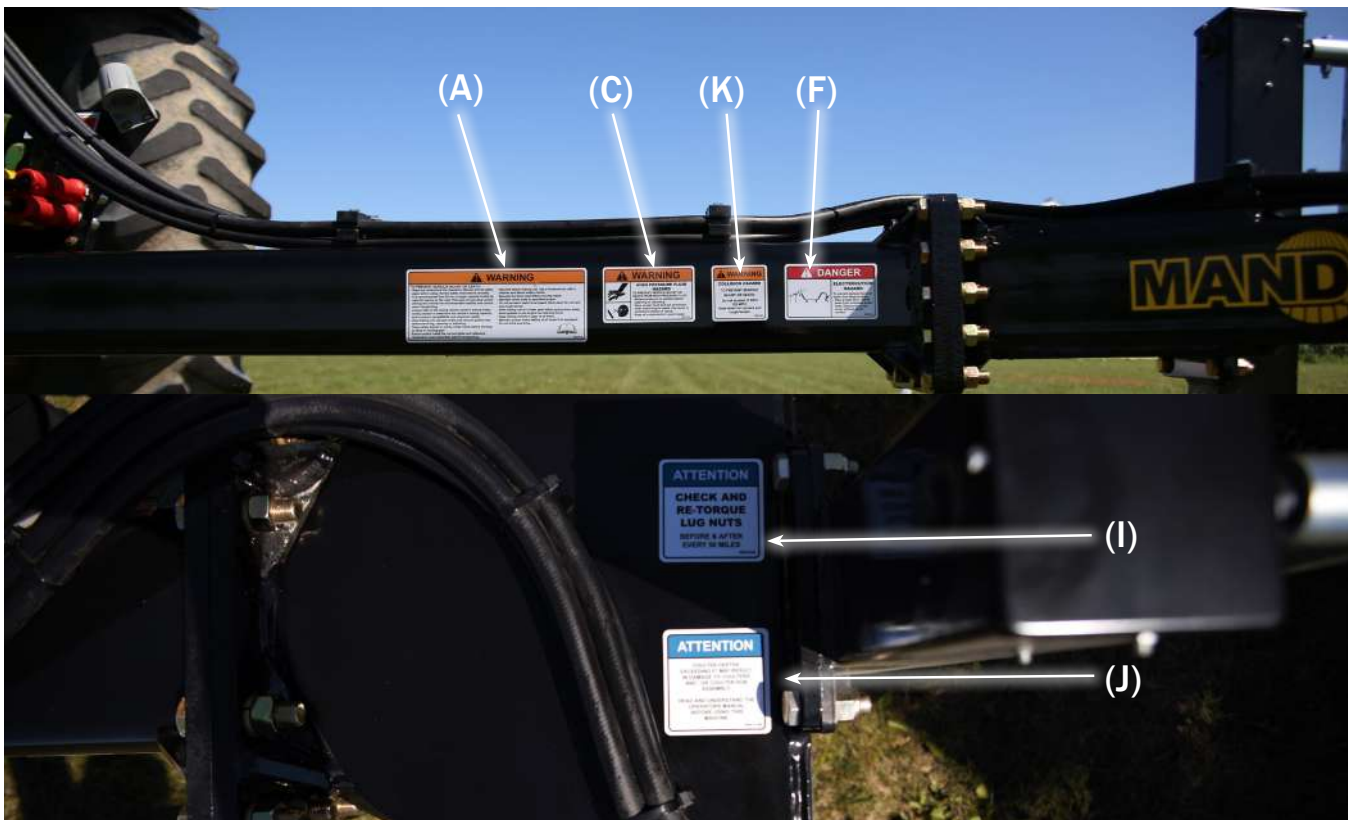

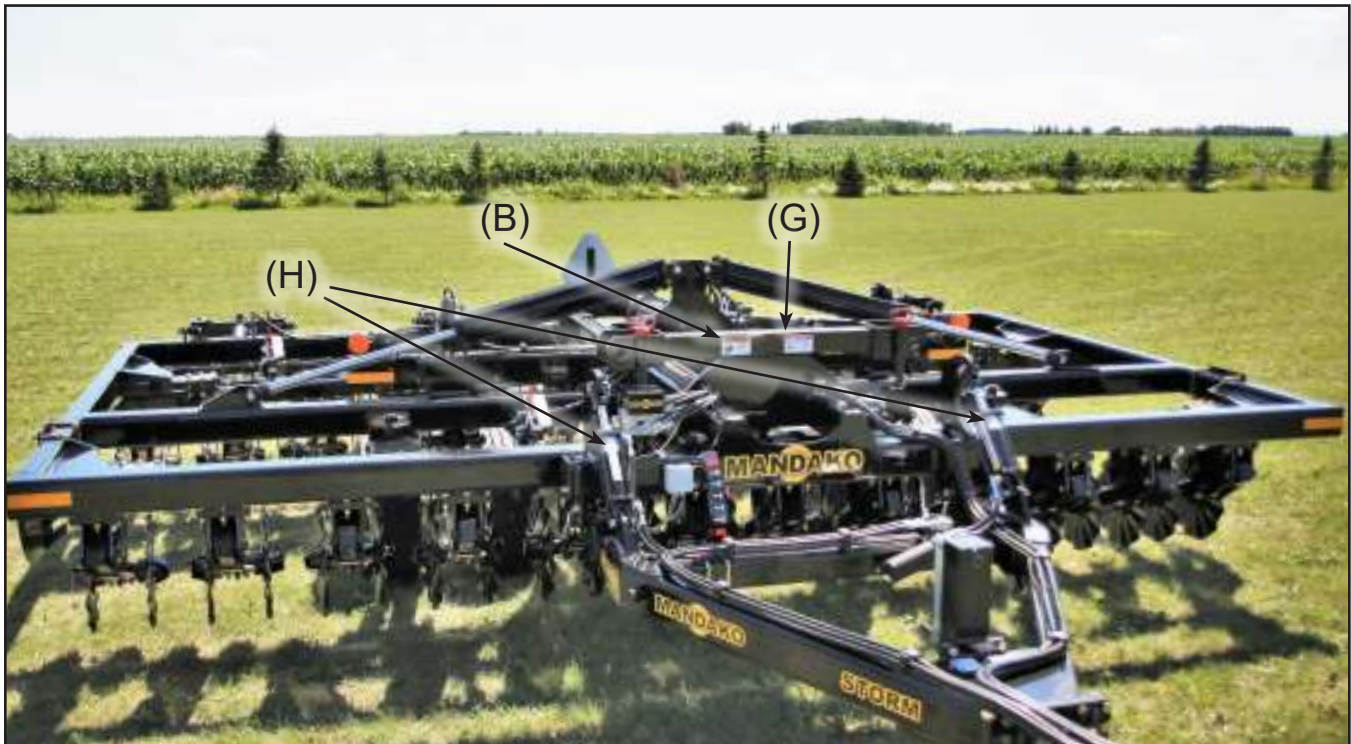
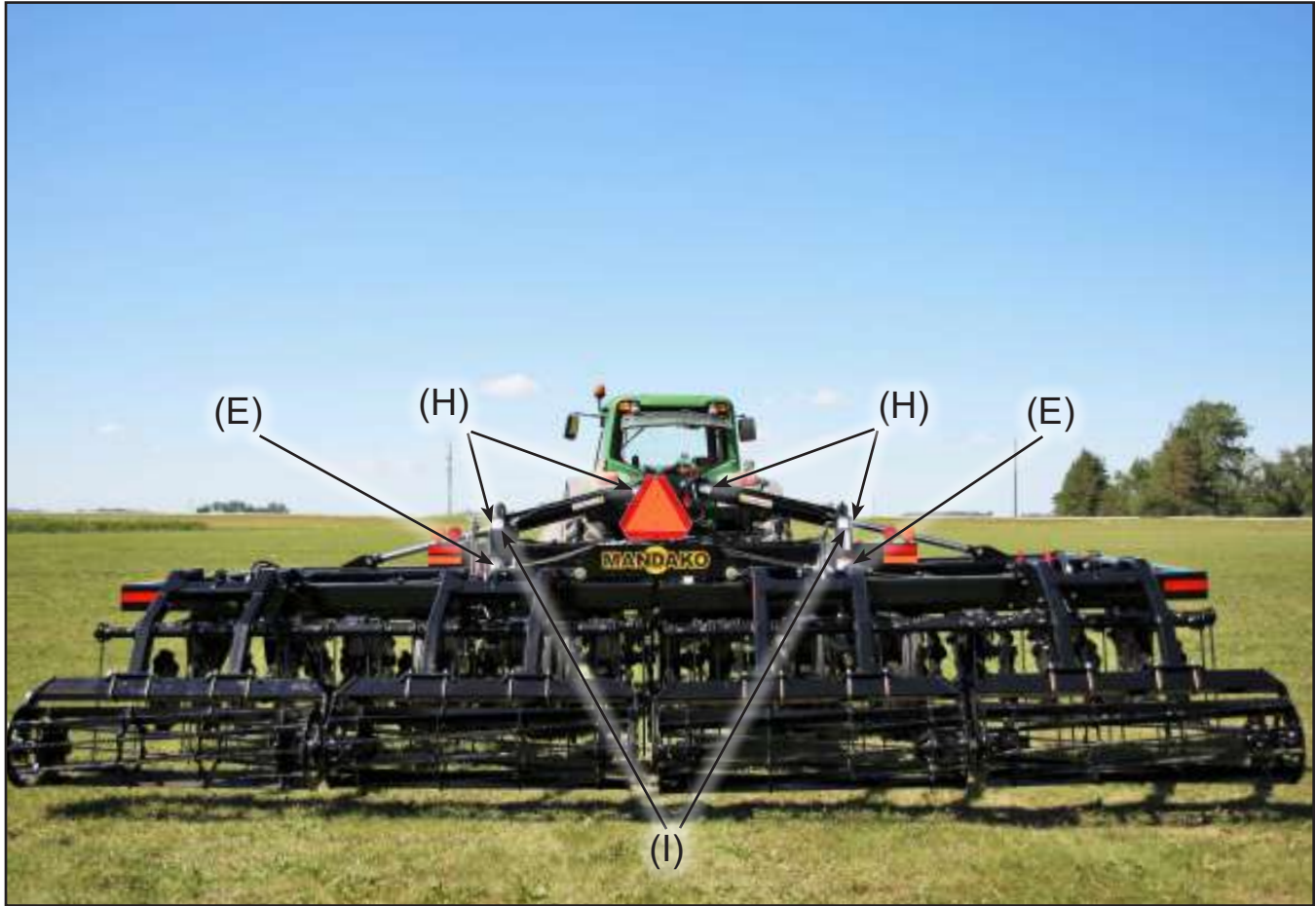



(N)

(M)

(L)

SECTION 3: OPERATION

- Read and understand the Operator's Manual, and all safety signs before using. Review safety instructions annually.
 - Place all controls in neutral, stop engine, set park brake, remove ignition key, and wait for all moving parts to stop before servicing, adjusting, repairing, or unplugging.
 - Install and secure all guards and shields before starting or operating.
 - Keep hands, feet, hair, and clothing away from all moving and/or rotating parts.
 - Do not allow riders on the Storm or tractor during operation or transporting.
 - Attach securely to towing unit using a hardened pin with a retainer and a safety chain.
 - Clear the area of all bystanders, especially children, before starting.
 - Stay away from frames and components when folding or extending wings. Keep others away.
 - Clean reflectors, SMV (Slow Moving Vehicle) emblem and all the lights before transporting. Ensure you are in compliance with all federal and local regulations regarding transport of equipment on public roads and highways.
 - Do not exceed a safe travel speed.
 - Use hazard flashers on tractor when transporting.
 - Before applying pressure to the hydraulic system, make sure all components are tight and that steel lines, hoses, and couplings are in good condition.
 - Stay away from overhead power lines when folding or extending wings. Electrocutation can occur without direct contact.
 - Fold wings and install transport lock brackets with its retainer over wheel lift cylinder before transporting.
 - Attach securely to towing unit using a hardened pin with a retainer and a safety chain.
 - Do not drive while impaired.
-

It is the responsibility of the owner and operator to read this manual. They must train all others before starting to work with the machine. Follow all safety instructions exactly. Safety is everyone's responsibility. By following recommended procedures, a safe working environment is provided for the operator, bystanders and the area around the work site.

Many features incorporated into this machine are the result of suggestions made by customers like you.

This manual will describe how to set the Storm to provide maximum field efficiency. By following the operating instructions in conjunction with a good maintenance program, your Storm will provide many years of trouble-free service.

3.1 MACHINE COMPONENTS

3.1.1 STANDARD MODEL

The Mandako Euro Storm Tillage Tool consists of a main frame with wings on each side that can fold up for transport or storage. Each wing is designed with hanging coulter toolbars to engage the soil. The toolbars can be angled up from 0° to 14° to provide a more aggressive residue cutting, soil moving, and residue mixing action. It is the responsibility of the operator to monitor the job being done and adjust the angle of the toolbars to provide the desired performance.

Each wing folds up for transport. Install cylinder stops around wheel lift cylinders before transporting. The wings hinge inside the frame to reduce the overall transport width.

Optional harrows and rolling baskets are available to mount on the back of the frame. The tine harrows are designed to evenly distribute residue and the pitch can be easily adjusted for varying conditions. The rolling baskets assist in breaking down clods and leaving a smooth field finish.

The fore and aft leveling of the machine is done by hydraulic cylinders on the hitch. The circuit is designed with a ball valve that allows the operator to lock the position in place.

Both front and rear toolbars are equipped with a position indicator to assist in positioning the angle of the toolbar. The toolbars can be angled from 0° to 14°.

Each machine is equipped with a single point depth control that is mounted to the front of the frame and plumbed into the wheel lift circuit. This allows the operator to control the working depth of the machine and ensures that the coulters always return to the same preset depth when lowered for working.

A 3-way electronic selector valve is mounted on the front of the frame which directs the oil flow from the yellow circuit to the desired function. The solenoids are controlled by a control box mounted in the cab (Item n).

Mud guards are installed on either end of the machine controlling the dirt that gets thrown from the coulters.

The main components of the unit are as follows:

- a. Transport Lock Pins
- b. Left Wing
- c. Right Wing
- d. Wheels
- e. Hydraulic Line Storage
- f. Coulters
- g. Coulter Toolbar
- h. Toolbar Angle Indicator
- i. Rolling Baskets
- j. Tine Harrows
- k. Hydraulic Ball Valve
- l. Single Point Depth Control
- m. 3-Way Electronic Selector Valve
- n. Operator Control Valve
- o. Hitch
- p. Frame Angle Indicator
- q. Transport Lock Bracket/Cylinder Stops
- r. Mud Guard
- s. Hitch Jack
- t. Bypass Valve
- u. Safety Switch

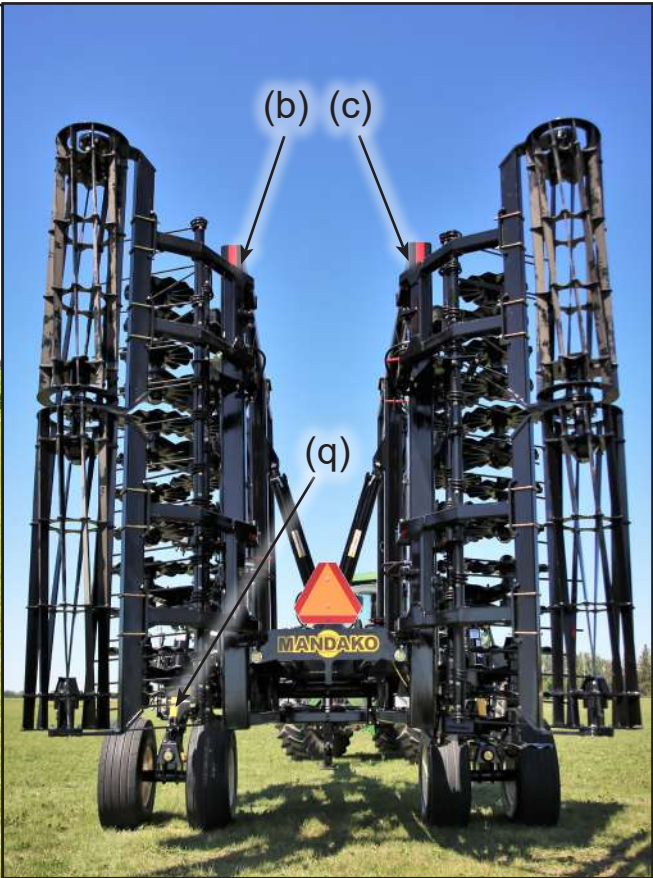
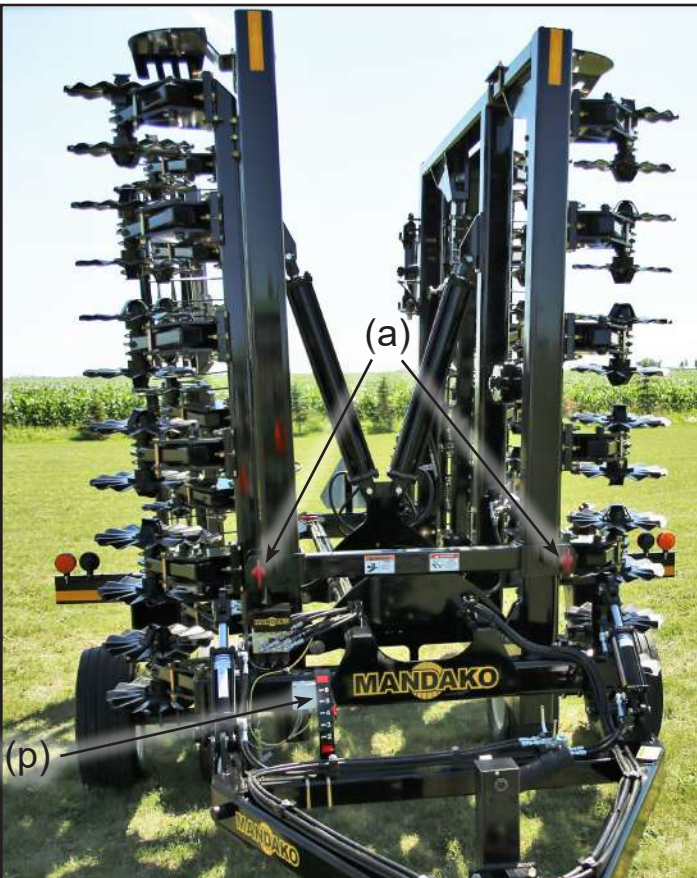

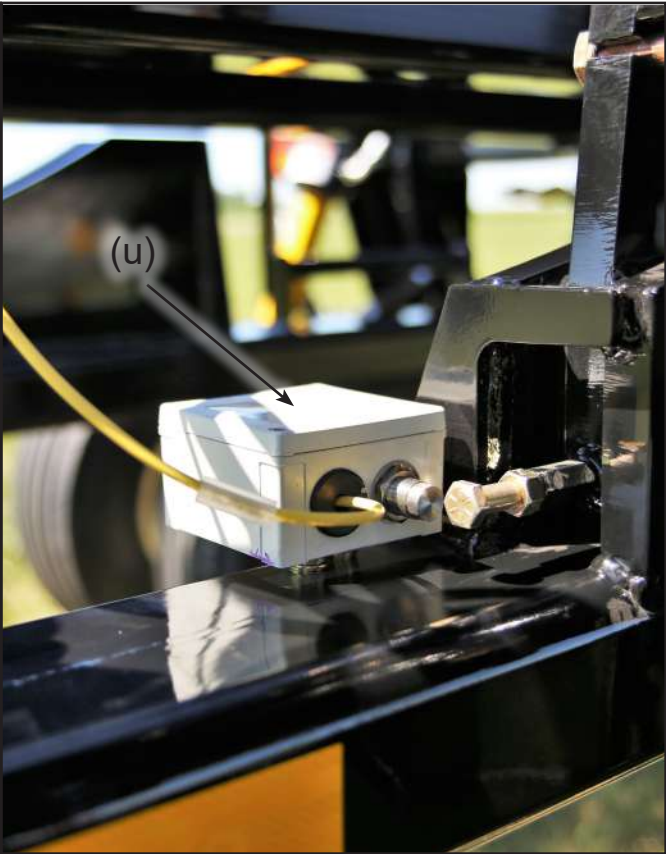
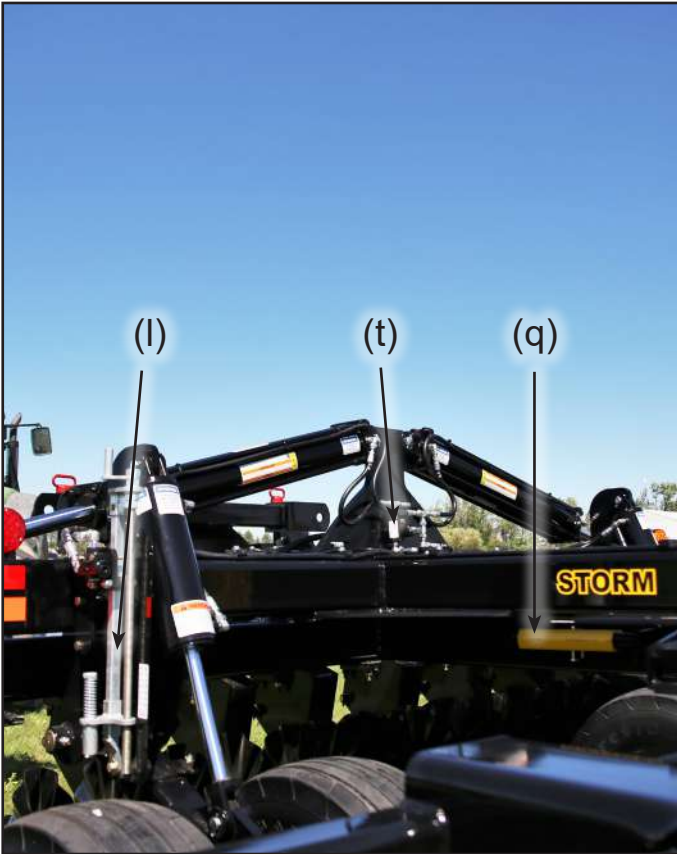

3.2 MACHINE BREAK-IN

There are no operational restrictions on the Storm Tillage Tool when used for the first time.

However, it is recommended that the following mechanical items be checked:

3.2.1 AFTER OPERATING FOR 1/2 HOUR

1. Re-torque all wheel bolts (See section 7.1)
2. Re-torque all fasteners and hardware.
3. Check that no hydraulic lines are being pinched or crimped. Re-route as required.
4. Inspect all hydraulic lines, hoses, fittings, and couplers for leaks. Tighten any leaking fittings.
5. Check for and remove all entangled material.
6. Lubricate all grease fittings except for bearings.

NOTE:

See Section 7 for specifications.

3.2.2 AFTER 5 HOURS AND 10 HOURS OF OPERATION

7. Re-torque all wheel bolts, fasteners, and hardware.
8. Inspect all hydraulic lines, hoses, fittings, and couplers for leaks. Tighten any leaking fittings.
9. Go to the normal servicing and maintenance schedule as defined in the Service and Maintenance section.

3.3 PRE-OPERATION CHECKLIST

Efficient and safe operation of the Mandako Storm requires that each operator reads the manual. They must understand the procedures and all related safety precautions.

A pre-operation checklist is provided to ensure the operator's personal safety and to maintain the Storm's good mechanical condition.

1. Lubricate the machine according to the schedule outline in section 4.2.
2. Use only a tractor of adequate power and weight to operate the Mandako Storm. See section 3.4 for recommendations.
3. Ensure that the Storm is properly hitched to the tractor. Ensure that a mechanical retainer is installed through the drawbar pin and that the safety chain is installed.
4. Inspect all hydraulic lines, hoses, fittings, and couplers for leaks. Tighten any leaking fittings.
5. Check the tires. Ensure they are inflated to their specified pressure.
6. Check the wheel bolts. Ensure they are tightened to their specified torque.
7. Remove all entangled material.
8. Ensure that all lights, reflectors, and the SMV (Slow Moving Vehicle) emblem, as required by the local highway authorities, are installed, clean, and in good working order.
9. Re-phase the hydraulic circuit according to Section 4.3
10. Perform an Air Pocket Purge on the hitch hydraulic circuit according to Section 4.4

3.4 EQUIPMENT MATCHING

To ensure the safe and reliable operation of the Storm, it is necessary to use a tractor with appropriate specifications.

Be certain that these requirements are met.

1. **Horsepower:**
The Storm Tillage Tool needs both power and mass to pull and stabilize the unit in all operating conditions.

The lower levels of power are appropriate for hard, level terrain, and higher levels for soft or hilly land. Extra mass is also required to maintain stability when slowing down or traveling downhill.

2. **Hydraulic System:**
The tractor’s hydraulic system must be capable of a minimum 10 gpm (38 lpm) at 1800 psi (12,420 kpa) but not exceed 3000 psi (20,684 kpa). The base Storm requires 4 hydraulic circuits for the hitch position, wheel lift, selector valve, and hydraulic basket position (Fig. 2). Switches that control the selector valves are mounted in the cab for access by the operator (Fig. 3). System ball valves are mounted on the hitch (Fig. 4).

- Ball valves (Fig. 4).
- 3-way electronic selector valve (Fig. 4).
- Operator Control Box (Fig. 3).

Size	Horsepower
13'	130-195
16'	160-235
20'	200-300

Table 1 - Suggested Horsepower Recommendation



Fig. 2 Hydraulic Circuits



Fig. 3 Selector Valve Control Box



Fig. 4 Ball Valves/3-way electronic selector valve

3.5 CONTROLS

Before starting to work, all operators should familiarize themselves with the location and function of all controls.

1. Shut-Off Valves:

The wing raise/lower and hitch position are designed with a valve to lock out or shut off these systems if required.

- Unlocked:
Turn valve handle parallel to hydraulic line to unlock the circuit (Fig. 5).
- Locked:
Turn valve perpendicular to hydraulic line to lock the circuit (Fig. 6).

2. 3-Way Electronic Selector Valve:

A 3-way electronic selector valve is mounted on the front of the frame, controlling the hydraulic system and the control switches in the cab (Fig. 7).

3. Hydraulic Circuit System:

The Storm requires 4 hydraulic outlets to operate all the circuits (Fig. 8).

- Hydraulic hitch
- Wheel lift
- 3-way electronic selector valve
- Selector Valve Control Box



Fig. 5 Circuit Unlocked



Fig. 6 Circuit Locked



Fig. 7 3-way electronic selector valve



Fig. 8 Hydraulic Circuits

4. Safety Switch

The safety switch is designed to prevent any contact between the tire and the coulter blade when transitioning to transport mode. The switch is magnetically activated, allowing hydraulic fluid to flow into the wing lift cylinders when the tool-bar is in its neutral position. If the tool-bar has not been adjusted to 0°, the switch will not allow the wing lift cylinders to operate (Fig. 9).

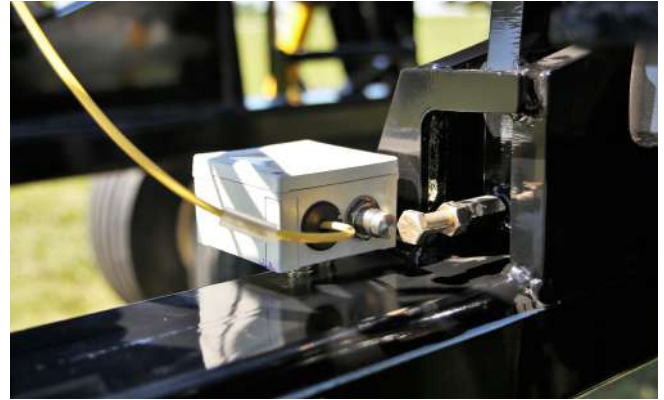

Fig. 9 Safety Switch

5. Control Box Switches:

The yellow hydraulic circuit provides oil to the selector valve mounted on the front of the frame. Switches controlling the valves are mounted in the cab with power provided through the cigarette lighter.

a. Wing lift (blue):

The blue toggle switch controls the power to the solenoid, which supplies oil to the wing position cylinders. Move the toggle to activate the circuit. Use the hydraulic control lever in the tractor cab to move the wing cylinder. When lowering the wings, hold the control lever until you hear the system go over relief. This will ensure that the wing cylinders fully extend into the slot on the wing bracket to allow the wing to go up and down (follow the ground contour) as the machine moves across the field. Move the hydraulic lever in the opposite direction to raise the wings. When wing operation has completed, return the toggle switch to its off or neutral position.



Fig. 10 Selector Valve Control Box

b. Front tool bar position (white):

The white toggle switch controls the power to the solenoid, which supplies oil to the front tool bar position cylinder. Move the toggle to activate the circuit. Use the hydraulic control lever in the tractor cab to move the front tool bar. Move the hydraulic lever forward and backward as needed to adjust and position the front tool bar. When wing operation has completed, move the toggle switch to its off or neutral position.



Fig. 11 Tool-bar Angle Indicators

c. Rear tool bar position (red):

The red toggle switch controls the power to the solenoid, which supplies oil to the rear tool bar position cylinder. Move the toggle to activate the circuit. Use the hydraulic control lever in the tractor cab to move the rear tool bar. Watch the scale on the left side of the frame to monitor the position of the tool bar. Move the hydraulic lever forward and backward as needed to adjust and position the rear tool bar. When toolbar operation is completed, move the toggle switch to its off or neutral position.

6. Single Point Depth Control:

Turning the depth adjuster adjusts when the plunger will come in contact with the depth control valve. (F)

When the frame is lowered (wheel assemblies raised), the 'return to depth' system should be set so the coulter blades always return to the desired operating depth throughout the field.

The system consists of:

- a. Plunger
- b. Marker
- c. Depth Gauge
- d. Depth Control Valve
- e. Wheel Assembly Linkage
- f. Depth Adjuster

To adjust:

- a. Using the wheel lift hydraulic circuit, raise the machine to its maximum height.
- b. Turn the depth adjuster clockwise or counterclockwise until the marker is at the desired depth on the depth gauge (Fig. 12).
- c. Monitor the machine performance and re-adjust as required.

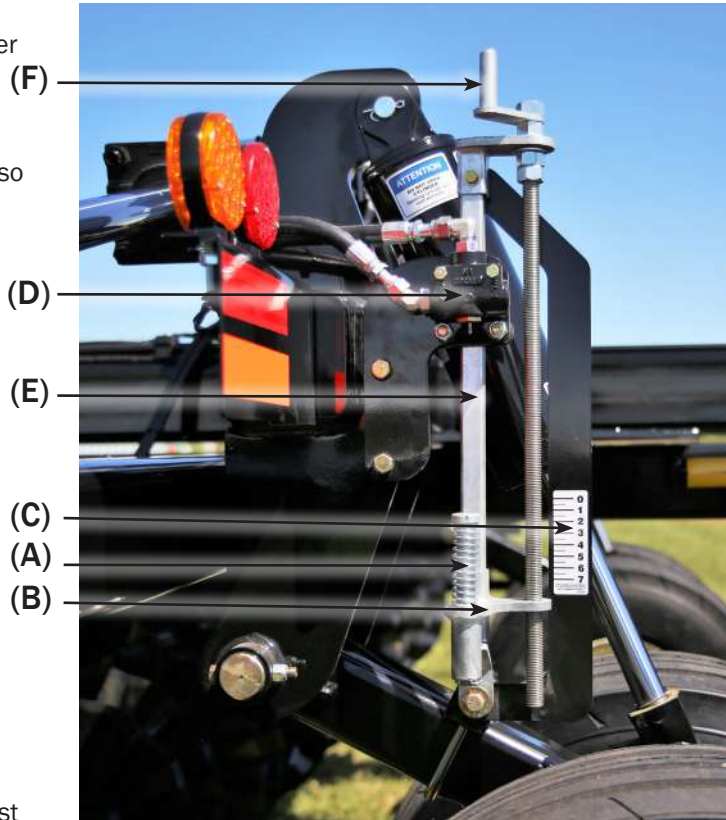

Fig. 12 Single Point Depth Control Mechanism

3.6 ATTACHING TO A TRACTOR

Follow this procedure when attaching the Storm Tillage Tool to a tractor.

1. Clear the area of all bystanders, especially small children.
2. Make sure there is enough room and clearance to safely back up to the machine (Fig. 13).
3. While backing up, use the jack to align the hitch and the drawbar (Fig. 14).
4. Stop tractor, set park brake, remove ignition key, and wait for all moving parts to stop before dismounting.
5. Use a drawbar pin with provisions for a mechanical retainer. Install the retainer (Fig. 15).
6. Attach safety chain around the drawbar cage to prevent unexpected separation (Fig. 16).



Fig. 13 Backing Up



Fig. 14 Aligning



Fig. 15 Drawbar Pin and Retainer



Fig. 16 Safety Chain

7. Stow the jack (Fig. 17):

- Pull out the pin
- Raise bar
- Raise jack



Fig. 17 Jack Active - Jack Stowed

8. Connect the wiring harness by inserting the terminal into plug on tractor. Route harness through hose retainer on hitch to prevent dragging on ground (Fig. 18).



Fig. 18 Wiring Harness

3.7 CONNECT HYDRAULIC SYSTEM

WARNING:
HIGH PRESSURE FLUID

Wear eye and hand protection when searching for leaks. Relieve pressure before adjusting . Keep components in good repair.

1. Use a clean cloth or paper towel to clean dirt and build-up from around the couplers and male tips.
2. Insert the male tips into the couplers. Ensure they are locked in place.
3. Route the hoses through the metal hose retainer on the hitch to prevent the hoses from dragging on the ground. Make sure there is enough slack to prevent hoses from being pinched when turning.
4. Check the function of each circuit. Ensure they function according to expectations. Reverse hoses if they do not.



Fig. 19 Stored



Fig. 20 Circuit 1



Fig. 21 Connected

3.8 CONNECT THE SELECTOR VALVE CONTROL SYSTEMS

Each Storm Tillage Tool is designed with a “yellow” hydraulic circuit to provide oil to the selector valve bank mounted on the front of the frame.

The control box is mounted in the cab and the power cord is plugged into the cigarette lighter outlet.

Follow this procedure when connecting the selector valve control switches:

1. Retrieve the switch assembly from its stored location. (Fig. 23)

IMPORTANT:

Tractor cabs are designed with an access opening to allow wires or the components to enter or exit the cab in a controlled manner rather than leaving a window or door open. Refer to tractor manual for its location. Place switch assembly in cab and then route wire through opening.

2. Mount switch control box in cab.
3. Connect power line to the cigarette lighter plug.
4. Route the wires out of the cab through the opening in the bottom rear edge of the cab.

IMPORTANT:

It is recommended that the switch assembly be removed from the tractor and Storm and stored inside in a secure location to prevent deterioration from the environment. Unplug the control wires at the terminal to remove switch assembly.

5. Insert assembly plug into terminal on control wiring harness (Fig. 24).
6. Reverse the above procedure when unhooking.



Fig. 22 Mounted/Power



Fig. 23 Selector Valve Control Box



Fig. 24 Plug Location, Plugged In

3.9 TRANSPORT TO FIELD CONVERSION

The Storm Tillage Tool is designed to be easily converted from transport to field configuration with minimal effort.

When converting, follow this procedure:

1. Clear the area of bystanders, especially small children.
2. Move the machine into an open area large enough to lower the wings. Do not move it into an area with overhead power lines or obstructions.
3. Fully raise the frame into its upright position.
4. Stop engine, set park brake, remove ignition key, and wait for moving parts to stop before dismounting.
5. Remove cylinder stops from wheel assembly and stow. Storage rods are located on the left and right sides, as shown in (Fig. 26).
6. Remove the transport lock pins (Fig. 27, 28): Each wing is held in place with a pin to prevent it from extending.
 - a. Remove left wing lock pin and stow with its retainer on the frame.
 - b. Remove right wing lock pin and stow with its retainer on the frame.



Fig. 25 Transporting



Fig. 26 Cylinder Stop and Storage



Fig. 27 Transport Lock Pins Installed



Fig. 28 Transport Lock Pins Removed and Stowed

7. Use the yellow hydraulic circuit with the control box toggle switches to control machine functions (Fig. 29).



Fig. 29 Yellow Circuit

8. Use the blue toggle switch on the control box to move the wings (Fig. 30).

9. Move the switch down to open the wing position circuit.



Fig. 30 Selector Valve Control Box

10. Use the hydraulic lever in the cab connected to the yellow circuit to lower one wing until it is completely down (Fig. 31).

11. Continue to hold the hydraulic lever to lower the second wing (Fig 31). Hold hydraulic lever until the hydraulic system goes over relief to ensure the cylinders are fully extending. Do not leave in float. Wing circuit should be locked.



Fig. 31 Lower Wing

Fig. 32 Lower Right Wing: Starting/Down

12. Lower the rolling baskets to the ground if appropriate for the application (Fig. 33). Ensure the hydraulic circuit is placed in float.
13. To prepare for the field operation:
 - a. Open the ball valves on the hitch frame (Fig. 34).
 - b. Use the blue circuit (hydraulic hitch) to adjust and set the frame angle to obtain the desired field performance (Fig. 35).
 - c. Use the white and red toggle switches to move and set the toolbar angles. Observe the scales on the frame to know their angle (Fig. 36).



Fig. 33 Lowering Rolling Baskets



Fig. 34 Ball Valves Open



Fig. 35 Frame Angle: Blue Circuit/Angle

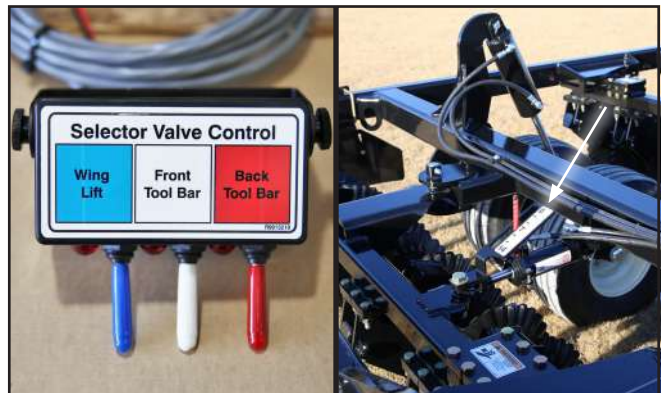

Fig. 36 Toolbars: Selector Valve Control Box/Scale

3.10 FIELD OPERATION

Although the Storm Tillage Tool is easy to use, each operator should review this manual to familiarize themselves with the Safety and Operating procedures.

When using this machine, follow this procedure:

1. Clear the area of bystanders, especially small children.
2. Attach the machine to the tractor. See section 3.6.
3. Review and follow the pre-operation checklist. See section 3.3.
4. Transport to working area.
5. Convert to field configuration. See section 3.9.
6. Open the valve in the hydraulic lines to the hitch cylinders by moving them parallel to lines (Fig. 36).
7. Use the hitch cylinders to set the fore-aft angle of the frame (Fig. 39).
8. Starting (Fig. 40):
 - a. With the tractor engine at approximately 1/3 throttle position, release clutch and move forward.
 - b. Lower machine into ground.
 - c. Increase throttle position until desired engine rpm is reached.
9. Stopping (Fig. 40):
 - a. Reduce engine rpm.
 - b. Raise machine out of ground by lowering wheel frame.
 - c. Engage clutch to stop forward motion of the Storm.



Fig. 37 Field Configuration



Fig. 38 Valves Open



Fig. 39 Fore-Aft Frame Angle



Fig. 40 Starting/Stopping

10. Wing Position:

Euro Storm hydraulic wing circuit should be locked in fully extended position.

11. Toolbar Angle:

Each toolbar is pinned at the pivot and is allowed to move in a slot in the wing frame on the other end. A cylinder on the toolbar moves the end in the slot. (Fig. 42)

- a. Front
- b. Rear

Vertical blades can be run at 0° , however, concave blades need to be run at a minimum of 3° to avoid improper ground engagement.

Each toolbar angle can be adjusted up from 0° to 14° with a tractor hydraulic circuit and the switch in the cab (Fig. 43). Set at 2° for minimum soil movement and residue mixing action. Increase the angle to increase the soil movement and residue mixing.

Adjust the toolbar angle appropriate for your application.

Both front and rear toolbars are designed with a scale to show the angle of the toolbar. Use the scales as a guide when setting the toolbar angle.

Use the yellow hydraulic circuit and the control box toggle switches in the cab to set the toolbar angle (Fig. 44).



Fig. 41 Anchor Bracket Slots



Fig. 42 Toolbar Angle



Fig. 43 Toolbar Angle: $0^\circ/14^\circ$

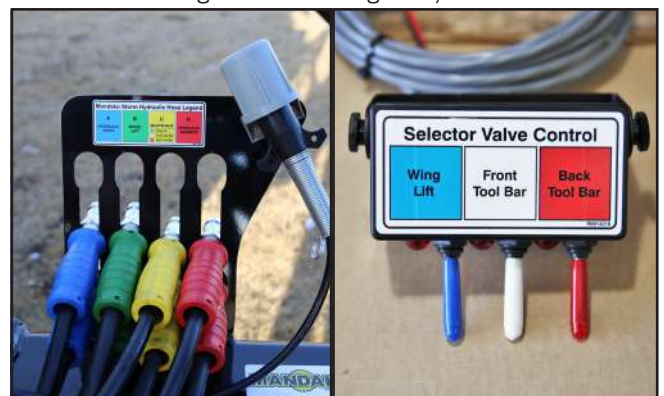

Fig. 44 Toolbar Controls: Yellow/Switches

12. Soil Moisture:

Although the Storm Tillage Tool will work in most soil moisture conditions, it is the responsibility of the operator to monitor the condition of the soil after being tilled. Clay soils that are wet will compress and compact during tilling and not be satisfactory. Sandy soils are less likely to compact during tilling. Allow the soil to dry out before tilling if compacting occurs.



Fig. 45 Field

13. Coulter Wear:

All coulters will wear as the Storm moves through the fields while working. The rate of wear depends on how abrasive the soil is. Always replace the coulters when they wear down to a 38 cm (15 inch) diameter. Operating when the diameter has decreased will allow the coulter hub to drag on the ground, damage bearing seals and cause bearing to fail. Always replace all the coulters at the same time to keep performance the same on all toolbars.



Fig. 46 Coulter Size

14. Coulter Style:

The Mandako Storm is designed with either straight or concave blades.

- a. Straight blade - Moves the soil in a vertical fashion while cutting and sizing without moving too much soil (Fig. 47).
- b. Concave blade - Aggressively sizes and chops the residue while incorporating it into the ground (Fig. 48).



Fig. 47 Coulter Style



Fig. 48 Coulter Style

15. Operating Depth:

The coulters on the toolbars cut into the soil or field as the wheels are raised off the ground. Use the position of the wheels to control the depth of the coulters/toolbars cutting into the soil. The coulters are designed to operate at depths of between 1 - 6 inches (25 - 300mm).



Fig. 49 Machine Position: Up

16. Travel Speed:

The operator must determine the appropriate speed for the terrain and field conditions. The recommended speed is 8-10 mph (13-16 kph), do not exceed 12mph (19kph). Slow down for rough, hilly or rolling terrain. To be effective, the coulters must remain on/in the ground during operation to allow for the cutting of the residue cover and working it into the soil. Select a speed that will keep the coulters in the ground, however minimum speed of 8 mph (13 kph) is required to obtain the desired performance (Fig. 51).



Fig. 50 Machine Position: Down

17. Single Point Depth Control:

Each machine is designed with a shut off valve in the hydraulic line to the wheel assembly position cylinder (Fig. 52). A mechanical linkage attached to the wheel assembly contacts the shut off valve to stop the wheel assembly motion and the coulters will always return to the same depth.

Determine the desired coulters depth for the application and set the linkage accordingly. Use the handle on the adjusting rod to change the coulters depth to fit the application.

It is not recommended to operate the Storm Tillage Tool deeper than 6 inches (150 mm).



Fig. 51 Travel Speed

a. Depth Control Handle.

Setting the system to appropriate operating depth will mean the machine will return to this depth whenever the unit is lowered into the ground when operating in the field.



Fig. 52 Single Point Depth Control

18. Fore-Aft Frame Angle:

The frame can be adjusted to change which toolbar engages the soil the most. Use the hitch cylinders to adjust the angle of the frame (Fig. 53, 54).



Fig. 53 Fore-Aft Frame Angle Front Down



Fig. 54 Fore-Aft Frame Angle Front Up

Generally operating with a level frame provides the most consistent results (Fig. 55).



Fig. 55 Frame Level

Close the valves in the hydraulic lines to the hitch cylinders to maintain the same frame angle when operating (Fig. 56).



Fig. 56 Hitch Valves Closed

19. Two Row Tine Harrows:

Optional two row tine harrows are mounted on the back of the frame behind the unit to evenly distribute residue (Fig. 57).

- a. Operators can adjust vertically as they wear.
- b. Operators can adjust the pitch of the harrows to accommodate various residue positions.

20. Rolling Baskets:

Rolling baskets are mounted on the back of the frame behind the harrows to break up clods and smooth the surface of the field. Hydraulic cylinders on each rolling basket frame, raise and lower the baskets. Raise the baskets in muddy or wet field conditions to prevent plugging (Fig. 58).

- a. Use the red hydraulic circuit to move and position the rolling baskets. Place this circuit into its float position to maintain the baskets in their working position.

21. Field Operation:

The Following procedure should be used to monitor the tillage and residue work-up to get the best performance for the application. Monitor and adjust the machine per these steps:

- a. Lower the wings and lower coulters to the ground.
- b. Set the toolbars to the 0° angle (Fig. 60).
- c. Start moving across the field at 3 - 4 mph (5 - 7 kph)
- d. Lower the coulters fully into the ground.
- e. Increase speed to 8 - 10 mph (13 - 16 kph)
- f. Drive 100 feet (30m) and look at the ground in front of the Storm and behind it.
- g. Move the toolbar angle in 2° or 3° angle increments and monitor the job.
- h. Adjust/set the angle of the toolbars in small increments to get the job done and minimize horsepower requirements.
- i. It is recommended to have the front and rear toolbars set to the same angle.
- j. Monitor the job an conditions change and adjust the toolbar angle as required.
- k. The residue should be cut up and mostly worked into the soil if soil permits.



Fig. 57 Two Row Tine Harrows - Vertical Adjust/Angle Adjust



Fig. 58 Rolling Basket Position - up/down



Fig. 59 Field



Fig. 60 Angles: Toolbar/Frame

22. Operating Tips:

- a. Ensure there is sufficient space and clearance to fully extend the wings. Do not stand next to frame when extending to prevent injury. Keep others away.
- b. Stay away from overhead power lines when raising or lowering the wings to prevent electrocution.
- c. Observe the scales of the toolbars and front frame to determine their angles. Use the scales as a guide to set the angle when adjusting to obtain the required performance.
- d. Always set the Single Point Depth Control linkage and valve system when the desired performance is obtained. In the same way, the machine will always return to same settings when operating.
- e. Always replace the coulters when they wear down to a 15 inch (38 cm) diameter. Operating when the diameter is less will allow the wheel assembly to drag on the ground, damage bearing seals and cause bearings to fail. Always replace all the coulters at the same time to keep performance the same on all tool bars.
- f. Set the angle of the tine harrows on the back of the frame. Angle the harrows back if the field is covered with a lot of crop material. Angling back allows the material to be shed by the tines as the machine moves over the field. Use the adjustment pin and holes in the top of the tine harrow frame to adjust and set the tine harrow angle (Fig. 64).



Fig. 61 Frame: Tilted/Locked

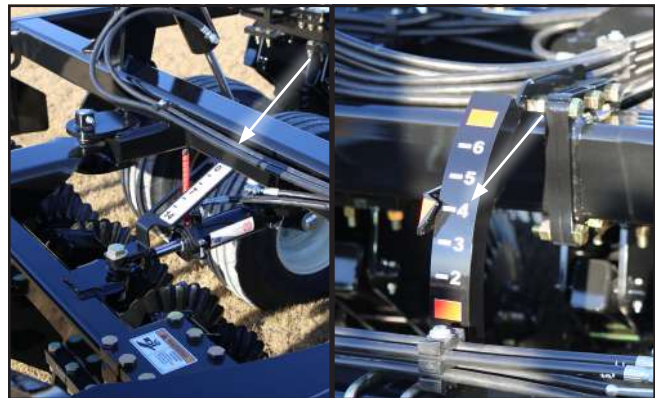

Fig. 62 Scale: Toolbar Angle/frame Fore-Aft Levelling



Fig. 63 Coulters (Typical)



Fig. 64 Tine Harrows: Adjustment/Angle

3.11 FIELD TO TRANSPORT CONVERSION

The Storm Tillage Tool is designed to be easily converted from field to transport configuration with minimal effort.

When converting, follow this procedure:

1. Adjust tool-bars to 0 to activate safety switch (see section 3.5).
2. Raise Frame.
3. Raise wings to rest against supports (Fig. 65).
 - a. Use the blue toggle switch on the control box to move the wings.
 - b. Move the switch down to open the wing circuit.
 - c. Use the hydraulic lever in the cab connected to the yellow to raise one wing completely.
 - d. Continue to hold the lever to raise the second wing.
4. Install transport lock pins (Fig 68.)
5. Level frame.
6. Fully raise frame to upright position.
7. Install cylinder stops over wheel lift cylinders (Fig. 66).
8. Close ball valve in front hitch cylinder hydraulic line (Fig. 67).



Fig. 65 Raise Wings



Fig. 66 Transport Lock Pins - Installed



Fig. 67 Cylinder Stops



Fig. 68 Hydraulic Ball Valve

3.12 TRANSPORTING

The Mandako Storm Tillage Tool is designed to be easily and conveniently moved from field to field.

When transporting, follow this procedure:

1. Ensure the machine is in transport mode (see section 3.11)
2. Ensure the machine is hitched correctly to the towing vehicle. Always attach the safety chain between the machine and the tractor and install a retainer through the drawbar pin.
3. Keep to the right and yield right-of-way to allow faster traffic to pass. Drive on road shoulder if permitted by law.
4. Make sure the SMV (Slow Moving Vehicle) emblem, all lights and reflectors that are required by local highway and transport authorities are in place. Check that they are clean and can be seen clearly by all overtaking and oncoming traffic.
5. It is not recommended that the machine be transported faster than 32 kph (20 mph). Table 2 gives the acceptable transport speed as the ratio of tractor weight to roller weight.
6. Do not allow riders on the machine.
7. Always use hazard flashers on the tractor when transporting unless prohibited by law.
8. During periods of limited visibility, use pilot vehicles and use extra lights on the machine.



Fig. 69 Wing Supports

Road Speed	Weight of Fully Equipped or Loaded Implement(s) relative to weight of tow vehicle
Up to 32 kph (20 mph)	1 to 1, or less
Up to 16 kph (10 mph)	2 to 1, or less
Do not tow	More than 2 to 1

Table 2 - Travel Speed vs Weight Ratio

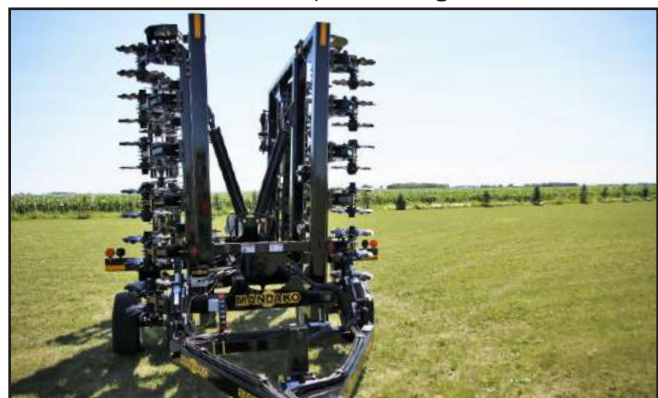

Fig. 70 Transport Mode

3.13 STORAGE

3.13.1 PLACE IN STORAGE

At the end of the season, the unit should be thoroughly inspected and prepared for storage. Repair or replace any worn or damaged components to prevent unnecessary down time at the beginning of the next season.

Follow this procedure before storing:

1. Remove all entangled material.
2. Thoroughly wash the unit with a pressure washer or water hose to remove all dirt, mud or debris.
3. Lubricate all grease points as per Section 4. Ensure all grease cavities are full to remove any water residue from washing.
4. Grease coulters bearings until grease comes out around hub.

IMPORTANT

Remove the plug from the coulters hub and install grease fitting. Grease coulters bearing. Remove fitting and store in a clean, secure location. Re-install plug. Coulters operate in a dirt-filled environment that can damage grease fittings and allow dirt to get into the hub. Dirt will damage bearings very quickly. Always install plugs in wheel hub before operating.

IMPORTANT

Grease fittings for the hubs are placed in the manual cannister when the machine is new from the factory. The fittings can be stored in the cannister when removed or placed in a secure location.

It is recommended to conduct/complete all yearly maintenance at the end of the season.

5. Inspect all hydraulic hoses, couplers and fittings. Tighten any loose fittings. Replace any hose that is badly cut, nicked, abraded or is separating from the crimped end of a fitting.
6. Touch up all paint nicks and scratches to prevent rusting.
7. Move the machine to its storage area. Inside a building is ideal.

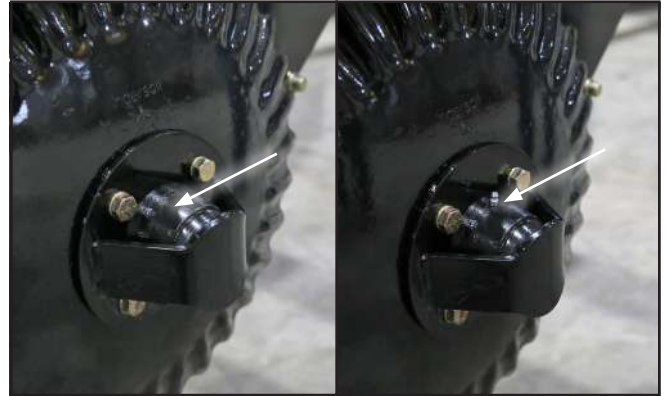

Fig. 71 Coulters Hubs: Plug/Grease Fitting



Fig. 72 Cannister (Typical)



Fig. 73 Wheel Hub



Fig. 74 Hydraulic Hoses

8. Place the machine into its transport or field configuration and rest the machine on the ground to relieve in the hydraulic system.
9. Place planks under the jack for added support if required.
10. Unhook the Euro Storm from the tractor. (Reverse Section 3.6)
11. Store unit in an area away from human activity.
12. Do not allow children to play on or around stored Storm Tillage Tool.
13. Apply a rust inhibitor or heavy grease to the exposed hydraulic cylinder rams to prevent rusting. Remove inhibitor or grease before using the machine again.

3.13.2 REMOVE FROM STORAGE

When removing this machine from storage, follow this procedure:

1. Clear the area of bystanders, especially small children.
2. Attach the unit to the tractor (See Section 3.6).
3. Check:
 - a. Electrical harness connections and components.
 - b. All hardware. Tighten as required.
 - c. Tire pressure.
 - d. All hydraulic lines, fittings and connections.
4. Remove grease fittings and install plugs in each hub to prevent dirt from entering.
5. Lubricate all grease fittings (as per Section 4).
6. Clean rust inhibitor or grease from exposed cylinder ram ends.
7. Replace any worn or defective parts.
8. Go through the Pre-Operation Checklist before using machine. (See Section 3.3)



Fig. 75 Field



Fig. 76 Transport

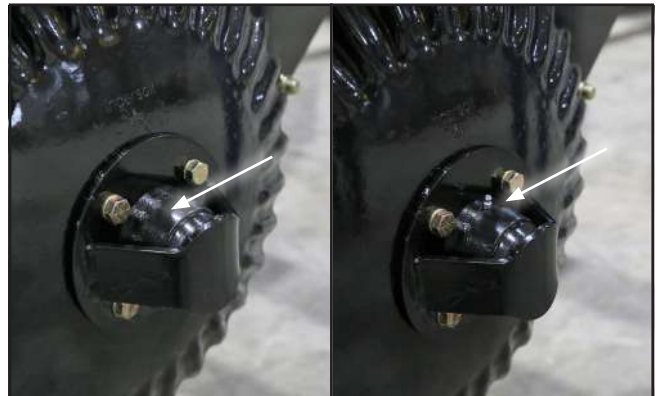

Fig. 77 Coulters Hubs: Plug/Grease Fitting

Page intentionally left blank.

SECTION 4: SERVICE AND MAINTENANCE

- Good maintenance is your responsibility. Poor maintenance is an invitation to trouble.
- Follow good shop practices.
 - Keep service area clean and dry.
 - Ensure electrical outlets and tools are in good working condition and properly grounded.
 - Use adequate light for the job at hand.
- Lower machine to the ground. Place all controls in neutral, stop engine, set park brake and remove ignition key. Wait for all moving parts to stop before servicing, adjusting, repairing or unplugging.
- Place stands or blocks under the frame before working beneath the machine or when changing tires.
- Always use personal protective devices such as safety glasses, gloves and hearing protection, when performing any service or maintenance work.
- When replacement parts are necessary for periodic maintenance and servicing, genuine factory replacement parts must be used to restore your equipment to its original specifications.
- A fire extinguisher and first aid kit should be kept readily accessible while performing maintenance on this equipment.
- Relieve pressure from hydraulic system before servicing or disconnecting from tractor.
- Before applying pressure to a hydraulic circuit, make sure all components are tight, and that steel lines, hoses and couplings are in good condition.
- When completing a maintenance or service function, make sure all safety shields and devices are installed before placing unit in service.

4.1 FLUIDS AND LUBRICANTS

4.1.1 GREASE

Use and SAE multipurpose high temperature grease with extreme pressure (EP) performance. Also acceptable is an SAE multipurpose lithium base grease.

4.1.2 STORING LUBRICANTS

Your machine can operate at top efficiency only if clean lubricants are used. Use clean containers to handle all lubricants. Store them in an area protected from dust, moisture and other contaminants.

4.1.3 GREASING

Refer to Section 4.1.1 for the type of recommended grease.

Use the Maintenance Checklist provided to keep a record of all scheduled maintenance.

1. Use a hand-held grease gun for all greasing.
2. Wipe grease fitting with a clean cloth before greasing, to avoid injecting dirt and grit.
3. Replace and repair broken fittings immediately.
4. If fittings will not take grease, remove and clean thoroughly. Also, clean lubricant passageway. Replace fittings if necessary.

4.2 SERVICING INTERVALS

The periods recommended are based on normal operating conditions. Severe or unusual conditions may require more frequent checks of the equipment and lubrication.

4.2.1 TWICE PER DAY OR EVERY 4 HOURS

NOTE:

Maintenance schedule applies for updated rolling baskets with bearing hub assemblies (as shown in Fig. 78).

4.2.2 DAILY OR EVERY 8 HOURS

1. Perform a brief cylinder re-phasing approximately every 5 hours (see section 4.3).
2. Perform a full cylinder re-phasing approximately every 24 hours (see section 4.3).
3. Perform an Air Purge on the Hitch hydraulic circuit. (see section 4.4)

4.2.3 EVERY 40 HOURS OR WEEKLY

1. Grease the wheel pivot assembly (1 location on each wheel) (Fig. 79).
2. Check torque. Re-torque if necessary.

4.2.4 ANNUALLY

1. Grease rolling basket bearings (both ends of each basket) (Fig. 78).
2. Grease coultter bearings until grease is expelled from bearings (Fig. 80).
3. Grease jack with one shot of grease (2 locations) (Fig. 81).
4. Clean and wash machine.

4.2.5 EVERY 3 YEARS

Rebuild wheel hubs

- a. Disassemble
- b. Clean
- c. Inspect all bearings
- d. Replace worn or damaged parts
- e. Repack with fresh grease
- f. Assemble

IMPORTANT:

The storm is designed with sealed wheel hubs.

DO NOT OVER GREASE!

Over-greasing will destroy the seal and minimize the life span of the wheel bearings.

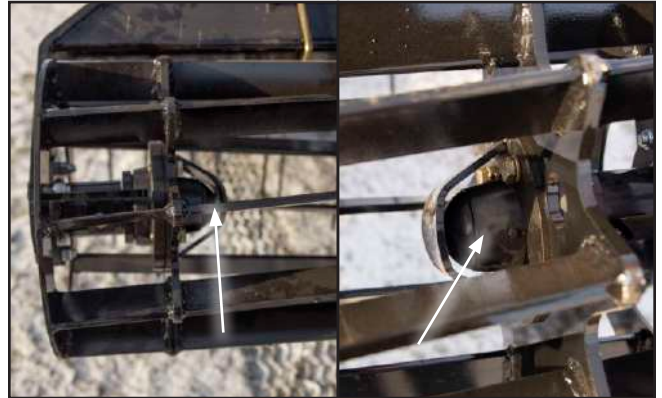

Fig. 78 Rolling Basket Bearings

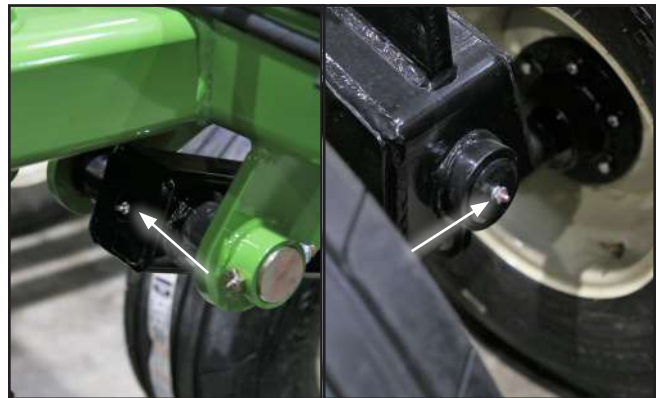

Fig. 79 Wheel Pivot



Fig. 80 Coultter Bearings



Fig. 81 Jack

4.3 HYDRAULIC RE-PHASING CIRCUITS

The Storm units are equipped with phasing cylinders on the wheel lift and tool bar circuits. It is the responsibility of the operator to understand hydraulic phasing circuits to be able to use the machine properly and efficiently and maintain consistent results.

4.3.1 HOW RE-PHASING CYLINDERS WORK

Phasing cylinders are plumbed in series with bores and rods sized in such a way so that all cylinders extend and retract equally. The hydraulic oil is forced out of the piston rod chamber of one cylinder and into the piston of the next cylinder. This process is repeated for however many cylinders are connected in that circuit. In the extended position the re-phasing orifices are exposed to allow the oil to flow into the next cylinder. The cylinders are filled with oil, vented, and aligned with the end stop.

4.3.2 RE-PHASING THE CIRCUIT

A brief re-phase of the hydraulic circuit should be done every 5 hours or every 100 acres. A full re-phase should be done at the beginning of each use, every 24 hours or every 500 acres. Re-phasing the system allows all cylinders to fully extend by purging the system of any entrapped air.

Brief Re-phase - Activate the hydraulic circuit to be re-phased by fully extending the cylinders and continue holding them (keep the circuit engaged) for an additional 30 seconds.

Full Re-phase - Activate the hydraulic circuit to be re-phased by fully extending the cylinders and continue holding them (keep the circuit engaged) for an additional 5 minutes.

IMPORTANT:

Re-phasing cylinders use "hard surface" seals that are prone to acceptable bypass. It is not recommended to use the cylinders to support the machine in a lifted position for long periods of time. When storing the machine ensure that the cylinder stops/transport lock brackets are installed and the weight of the machine is resting on the cylinder stops.

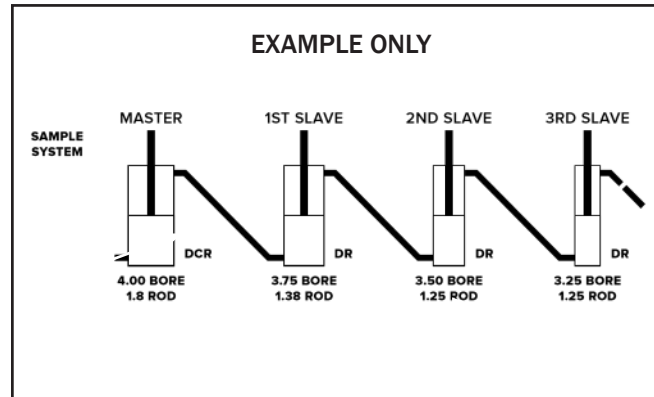

Fig. 82 Re-Phasing Circuit Diagram

4.4 AIR PURGING OF HITCH CIRCUIT

The Storm units are equipped with cylinders on the Hitch lift circuit. It is the responsibility of the operator to make sure the hitch circuit is free of air pockets to ensure proper floating hitch operation.

4.4.1 HOW AIR PURGING WORKS

Do the following to prevent the collection of Air pockets in the Hydraulic Circuit: Fully Extend and Retract the hitch cylinders 3 times.

4.4.2 LOCATION ADJUSTMENT

Use the Hitch Hydraulic Circuit to adjust the hitch to the operation setting after the hitch hydraulic circuit is free of air pockets.

4.5 COULTER SHANK BODY ADJUSTMENT

When changing coulters blades, the shank bodies on the rear toolbar may require adjustment.

Straight blades should be installed on the inside of the shank body (as shown in Fig. 83).

Concave blades should be installed on the outside of the shank body (as shown in Fig. 84).

Follow these steps when changing from straight blades to concave blades:

1. Remove/loosen bolts from shank body (Fig. 83).
2. Move shank body over to other end of slot (Fig. 84).
3. Tighten bolts.
4. Install blades.

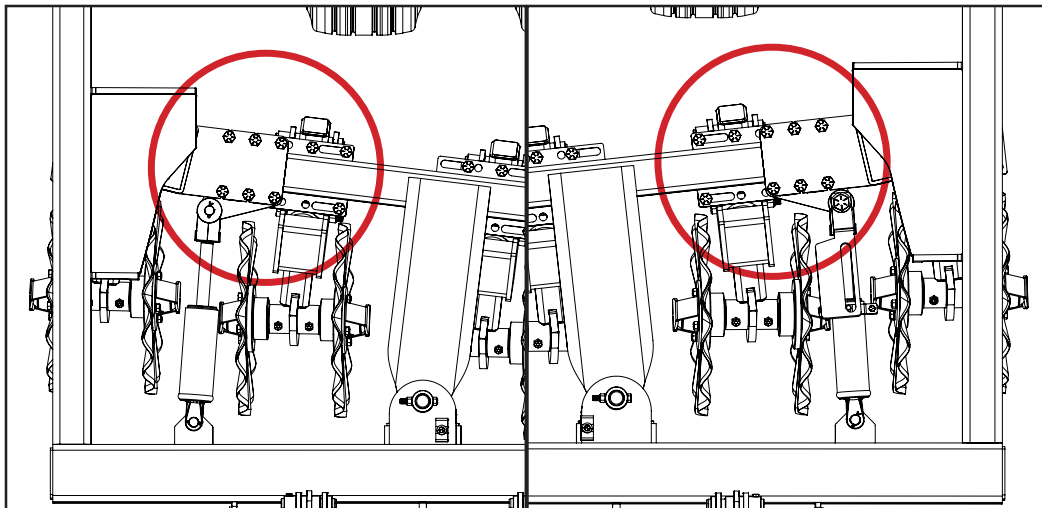

Straight Blade Back Left Fig. 83 Shank Body with Straight Blade Straight Blade Back Right

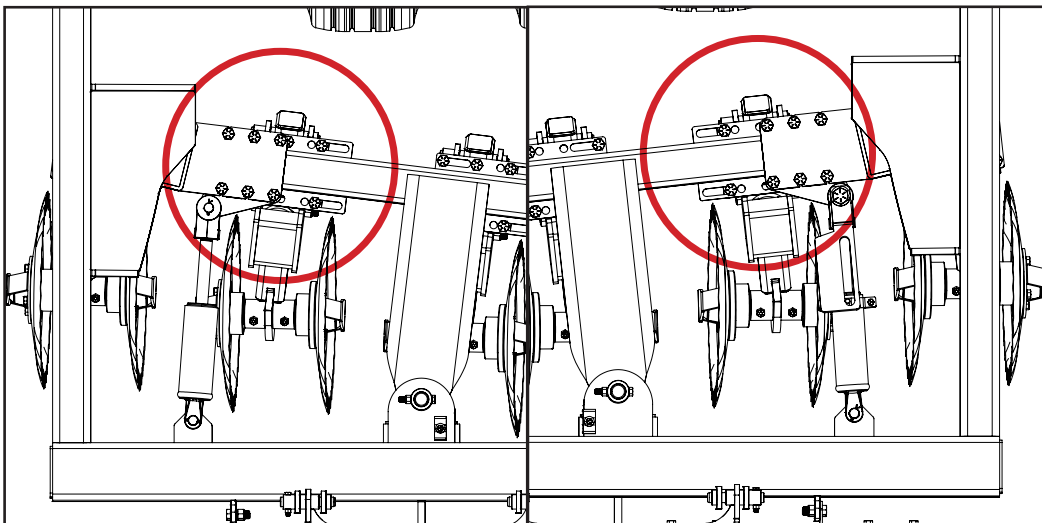

Curved Blade Back Left Fig. 84 Shank Body with Curved Blade Curved Blade Back Right

4.6 SERVICE RECORD

The Servicing Intervals section is only a guide under good conditions. Under extreme, or unusual circumstances adjust service timing accordingly.

Copy this page to continue record.

	Date													
Maintenance	Serviced By													
DAILY OR EVERY 8 HOURS														
Grease Wheel Pivots														
ANNUALLY OR EVERY 3000 ACRES														
Grease Coulter Bearings														
Grease Rolling Basket Bearings														
Grease Jack														
Repack Wheel Bearings														
Clean and Wash Machine														

	Date													
Maintenance	Serviced By													
DAILY OR EVERY 8 HOURS														
Grease Wheel Pivots														
ANNUALLY OR EVERY 3000 ACRES														
Grease Coulter Bearings														
Grease Rolling Basket Bearings														
Grease Jack														
Repack Wheel Bearings														
Clean and Wash Machine														

Page intentionally left blank.

SECTION 5: TROUBLESHOOTING

The Storm is a simple and reliable system that requires minimal maintenance.

The problems which you may encounter, their causes and solutions, are listed below.

If you encounter a problem which is difficult to solve, even after having read through this section, please contact your local distributor or dealer. Before you call, please have this Operator's Manual and the unit's serial number ready.

PROBLEM	POSSIBLE CAUSE	POSSIBLE CORRECTION
Residue not cut up.	Toolbar angle too small. Machine not deep enough. Coulters toolbar angle decreasing. Dull, worn coulters.	Increase coulters toolbar angle. Increase depth of coulters. Replace worn coulters. Tractor hydraulics leaking. Replace coulters,
Machine lifts unevenly.	Cylinder not in phase.	Extend re-phasing lift cylinders fully for 5-30 seconds to allow resetting of cylinders (can be done regularly during operation). Important with new machine to purge air from hydraulic system. (Section 4.3)
Not cutting evenly, or "dog-legging"	Rear coulters set at too aggressive an angle.	Set rear coulters at 2° - 4° less than front coulters. Use machine hitch cylinders to set front coulters to cut deeper than rear.
Harrows plugging.	Harrows set too straight.	Increase harrow angle. Increase coulters action to bury more trash.

PROBLEM	POSSIBLE CAUSE	POSSIBLE CORRECTION
Bouncing of Machine during Operation.	Air in hydraulic hitch circuit. Machine fore/aft not level. Tire pressure too high for conditions. Excessive ruts in the field. Machine depth not adequate or angle too high for conditions. Speed too high for conditions. Wing cylinders not locked in fully extended position.	Perform “Air Purging” of hitch Circuit in section 4.4. See “Fore/Aft frame angle” sec. 3.10 Lower tire pressure on wing (and main frame if required). Try changing direction of travel. Adjust depth or angle for conditions. Slow down travel speed. Fully extend wing lift cylinders and lock in position.
Tool Bar Cylinders not even.	Cylinders out of phase.	Perform a full rephase on the toolbar circuit (Section 4.4).
Wings will not lift.	Safety Switch not activated.(Fig. 9) Safety Switch Activation Bolt out of adjustment.	Move gang angles to 0°. Adjust Bolt at magnetically activated switch. Bolt should be at about 1/4” from “switch” when at 0° gang angle. (see Fig. 9, Section 3.5)

SECTION 7: REFERENCE

For information not included here, or for a digital copy of this manual, please call your dealer, or Mandako directly for assistance (1-888-525-5892).

Specifications may change without notice.

7.1 BOLT TORQUE

CHECKING BOLT TORQUE

The tables shown below give correct torque values for various bolts and cap screws. Tighten all bolts to the torques specified in chart unless otherwise noted. Check tightness of bolts periodically, using bolt torque chart as a guide. Replace hardware with the same strength bolt.

IMPERIAL BOLT TORQUE SPECIFICATIONS

Bolt Diameter "A"	Bolt Torque •					
	SAE 2 (N.m) (lb-ft)		SAE 5 (N.m) (lb-ft)		SAE 8 (N.m) (lb-ft)	
1/4"	8	6	12	9	7	12
5/16"	13	10	25	19	36	27
3/8"	27	20	45	33	63	45
7/16"	41	30	72	53	100	75
1/2"	61	45	110	80	155	115
9/16"	95	60	155	115	220	165
5/8"	128	95	215	160	305	220
3/4"	225	165	390	290	540	400
7/8"	230	170	570	420	880	650
1"	345	225	850	630	1320	970
1-1/8"	651	480	1077	794	1939	1430
1-1/4"	508	375	1498	1105	2678	1975

Coulter hub bolt torque spec

- 120 ft/lbs. with loctite

Lug bolt torque specs

- 8-Bolt 133 ft/lbs
- 6-Bolt 103 ft/lbs

Torque figures indicated above are valid for non-greased or non-oiled threads and heads unless otherwise specified. Therefore, do not grease or oil bolts or cap screws unless otherwise specified in this manual. When using locking elements, increase torque values by 5%.

- Torque value for bolts and cap screws are identified by their head markings.

7.2 TIRE PRESSURE

The recommended tire pressure is specific to the tires on your machine. Match your tires to the table below to find the right tire pressure for your tire. Never exceed the manufacturer's maximum tire pressure rating!

8 Bolt Assemblies	73 PSI
6 Bolt Assemblies	73 PSI

7.3 HYDRAULIC FITTING TORQUE

Pipe Rigid - Tapered Pipe Threads (NPTF, N/NF) - Carbon Steel			
Pipe Size	Turns-from-finger	Max ft-lbs	Max N-m
1/8" (-2)	3/4 - 1 3/4	12	16
1/4" (-4)	3/4 - 1 3/4	25	34
3/8" (-6)	3/4 - 1 3/4	40	54
1/2" (-8)	1/2 - 1 1/2	54	73
3/4" (-12)	1/2 - 1 1/2	78	106
1" (-16)	1/2 - 1 1/2	112	152
1 1/4" (-20)	1/2 - 1 1/2	154	209
1 1/2" (-24)	1/2 - 1 1/2	211	286
2" (-32)	1/2 - 1 1/2	300	407
For reference only, Source: Air-Way Manufacturing Co. - Carbon Steel Hydraulic			
Stud End O-Ring Boss (ORB) SAE (U/UF)			
		Carbon Steel	
Tube Size	Thread UNF-2A	Max ft-lbs	Max N-m
-2	5/16" - 24	6-7	8-9
-3	3/8" - 24	8-9	11-12
-4	7/16" - 20	13-15	18-20
-5	1/2" - 20	17-19	23-26
-6	9/16" - 18	22-24	29-33
-8	3/4" - 16	40-43	49-53
-10	7/8" - 14	43-48	59-64
-12	1 1/16" - 12	68-75	93-102
-14	1 3/16" - 12	90-99	122-134
-16	1 5/16" - 12	112-123	151-166
-20	1 5/8" - 12	146-161	198-218
-24	1 7/8" - 12	154-170	209-231
For reference only, Source: Air-Way Manufacturing Co. - Carbon Steel Hydraulic			
O-Ring Face Seal Fitting (ORFS) (F/FF)			
Tube Size	Turns-from-finger	Torque ft-lbs	Torque N-m
-4	9/16 - 18	10-12	14-16
-6	11/16 - 18	18-20	24-27
-8	13/16 - 16	32-35	43-47
-10	1 - 14	46-50	60-68
-12	1 3/16 - 12	65-70	90-95
-16	1 7/16 - 12	92-100	125-135
-20	1 11/16 - 12	125-140	170-190
-24	2 - 12	150-165	200-225
For reference only, Source: Air-Way Manufacturing Co. - Carbon Steel Hydraulic			

7.4 MECHANICAL SPECIFICATIONS

EURO STORM

Specifications

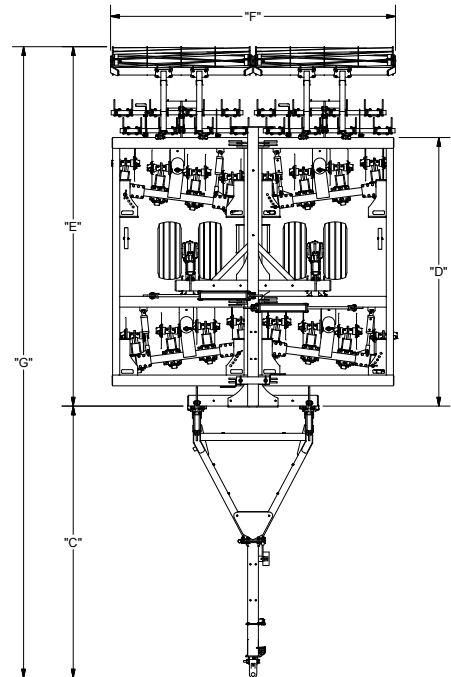
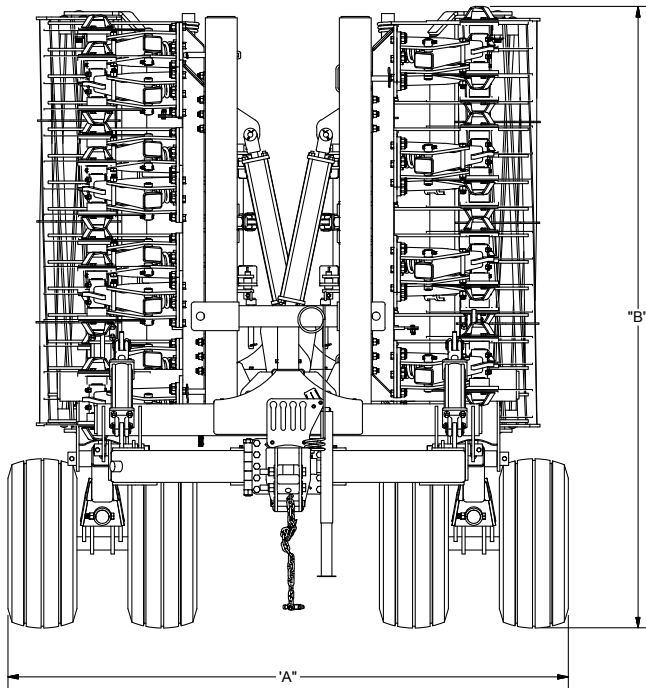

Dimension	Unit Size		
	13'	16'	20'
Frame Sections	2	2	2
Transport Width (A)	9'-8"	9'-8"	11'-2"
Transport Height (B)	9'-9"	11'-10"	12'-9"
Hitch Length (C)	12'-7"	12'-7"	12'-7"
Blade Working Length (D)	12'-6"	12'-6"	12'-6"
Complete Working Length (E)	16'-8"	16'-8"	16'-8"
Working Width (F)	13'-4"	17'-5"	19'-10"
Transport Length (G)	29'-3"	29'-3"	29'-3"
Depth Capabilities	1"-6"	1"-6"	1"-6"
Angle Adjustability	0°-14°	0°-14°	0°-14°
Coulter Blade Spacing	10"	10"	10"
Effective Cut Spacing	5"	5"	5"
Tine Spacing (2-row)	5"	5"	5"
Tine Spacing (3-row)	3-3/8"	3-3/8"	3-3/8"
Hyd. Req. (@1800PSI)	10 GPM (38 LPM)	10 GPM (38 LPM)	10 GPM (38 LPM)
Hyd. Req. (Ports)	4	4	4
Minimum Horsepower Req.	130+	160+	200+
Tire Size	320/70R15	320/70R15	440/55R18
Total Weight with Harrows and Baskets	12.5 L	12.5 L	12.5 L
	13,850	15,750	18,050

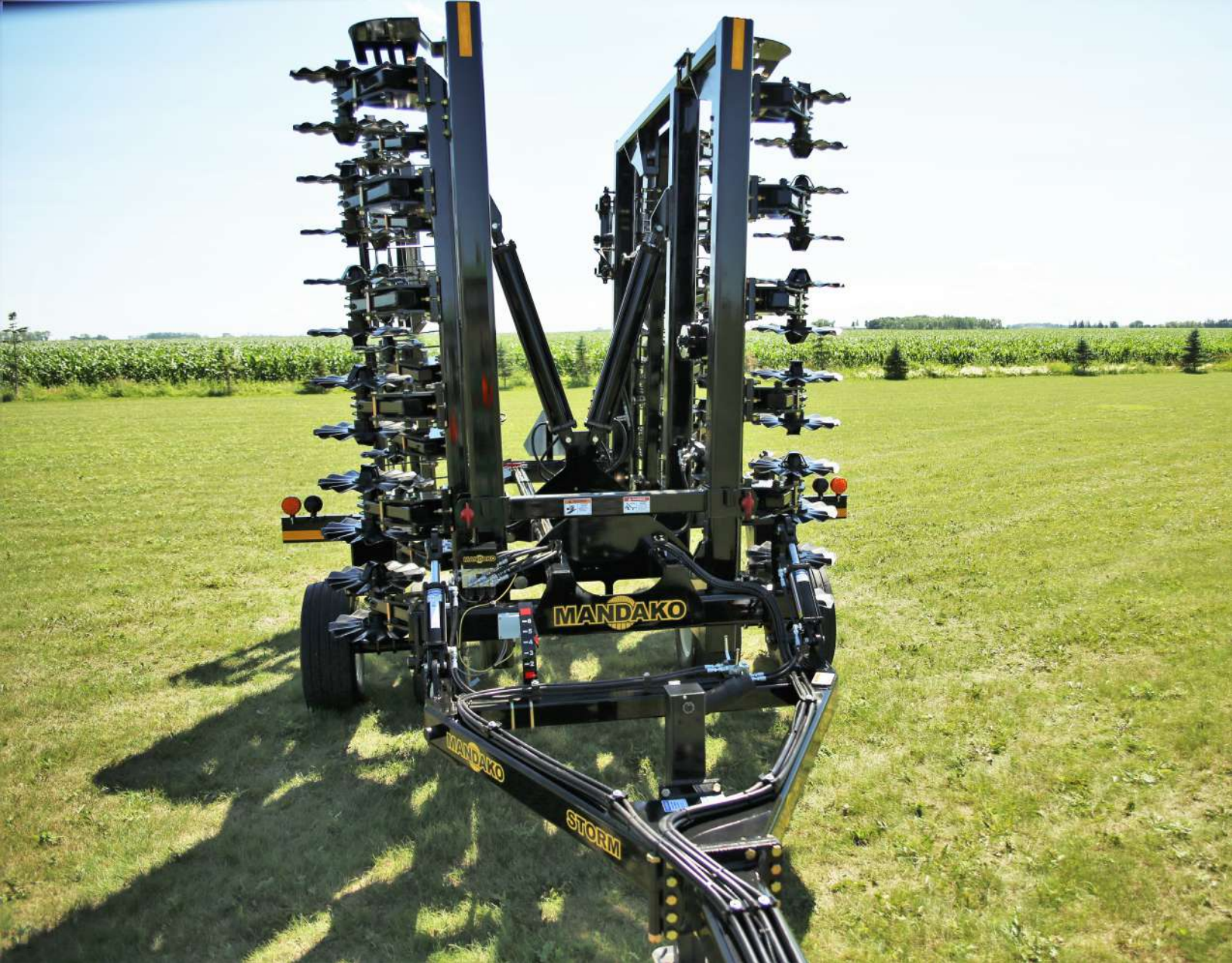

REVISION: 1.0

PART #: R9912034

RELEASED: JULY 13, 2023

Box 379 | 12159B Hwy 306

Plum Coulee, MB R0G 1R0

(888) 525-5892

info@mandako.com

www.mandako.com

MANDAKO AGRI MARKETING (2010) LTD.



Printed in Canada